

AT/ATR-FD SERIES

AC Current Transducers

AT/ATR-FD Series AC Current Transducers provide a current sensor and analog output signal conditioning in a single package. The large, easy-to-install solid-core design allows for quick installation even in applications where there are multiple conductors per phase. Just thread the conductor through the extra large aperture and reconnect on the other side. The transducer output is powered from excitation voltage of around 24 VDC, using just two wires. The sensor mounts on a back panel or a DIN rail, and is designed to accommodate wire sizes for loads up to 400 A.



AC Current Transducer Applications

Monitor Large Machines

- Detect over or undercurrent conditions before they cause breakdowns or interlock one process with another.

Water Delivery and Treatment

- Detect open discharge lines.
- Sense clogged filters or blocked intake to pumps.
- Measure increased current to show failing bearings or pump impeller cavitation.

Generators

- Shed noncritical loads when demand reaches a set level.

Shredders

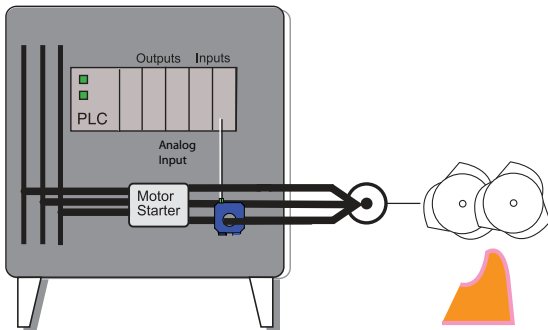

Monitor a shredding operation to measure current usage, enabling automatic shut down if the blades become jammed or overloaded.

- For additional Application Examples, go to www.nktechnologies.com/applications

AC Current Transducer Features

4–20 mA Analog Signal Proportional to AC Current

- Both average responding and True RMS models available.
- Compatible with most automation and control systems.

2-Wire Loop Powered

- Simple and reliable connection.

Factory Calibrated with Five Year Warranty

- Choice of three ranges : 0–200, 300 or 400 A.
- Designed for longest life and reliability.

Solid-core Case

- Sensing window provides ample space for a bus bar, a single conductor or multiple conductors.

DIN Rail or Panel Mount

- Simply snap onto DIN rail* or attach with screws to a panel for secure mounting.

UL/cUL and CE Approved

- Accepted worldwide.

*For information on the DIN rail accessories kit, see page 140.

OEMs Test & Evaluation Units for OEMs
Free program expedites evaluation process. See page 3 for details.

AC Current Transducer Dimensions

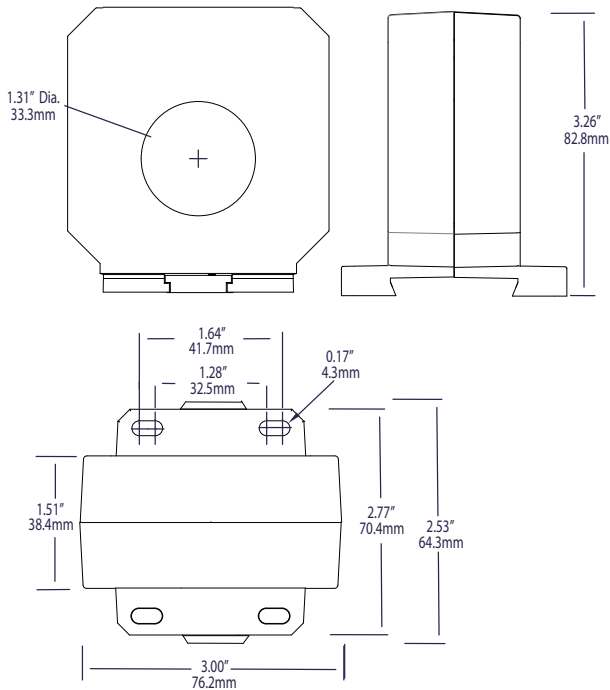

AC Current Transducer Connections

Single Transducer Installation

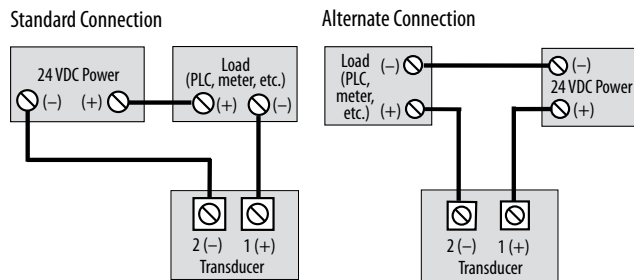

Loop Power Requirement

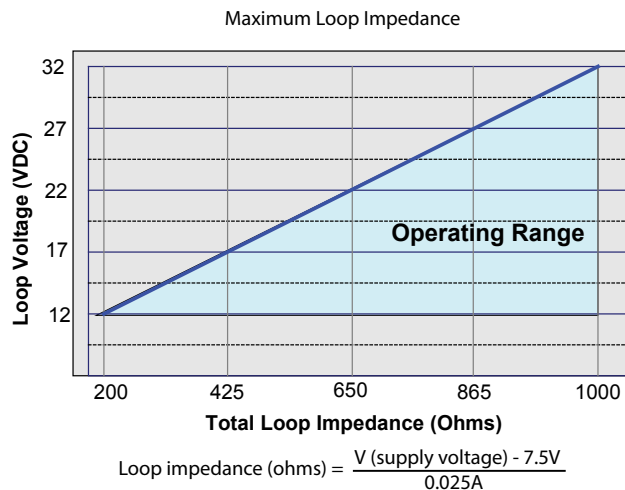

AC Current Transducer Specifications



Power Supply	Loop-powered
Power Consumption	<2 VA
Output Signal	4–20 mA loop-powered, average or True RMS (max. 28 mA)
Output Impedance	<660 Ω @ 24 VDC
Accuracy	1.0% FS
Response Time (90% step change)	• AT: 300 ms • ATR: 1.4 sec.
Range	• AT2: 0–200 A • AT3: 0–300 A • AT4: 0–400 A
Frequency Range	• AT: 40–400 Hz • ATR: 20–400 Hz
Isolation Voltage	UL listed to 1270 VAC, tested to 5 kV
Case	UL94 V-0 Flammability Rated
Environmental	-4 to 122°F (-20 to 50°C) 0–95% RH, non-condensing
Listings	UL/cUL, CE

AC Current Transducers

AC Current Transducer Ordering Information

Sample Model Number: ATR2-420-24L-FD

AC True RMS current transducer, 0–200 A range, 4–20 mA output, 24 VDC loop-powered, solid-core case, DIN rail mounting.



(1) Output Type	Average Responding (Blank)
R	True RMS
(2) Range	2 0–200 A
3	0–300 A
4	0–400 A
(3) Output	420 4–20 mA
(4) Power Supply	24L 24 VDC loop-powered
(5) Case Style	FD Solid-core, top terminals, DIN rail or panel mounting

