

PD6060

PROVU® Dual-Input Process Meter



PROVU®
SERIES

SUPER-BRIGHT LEDs
Our Brightest Display Ever

MeterView Pro
USB Install



DUAL-INPUT
PROCESS

- Dual-Input Process Meter with Math Functions
- Addition, Difference, Average, Multiplication, Division, Min, Max, Weighted Average, Ratio, Concentration, & More
- 0-20 mA, 4-20 mA, 0-5 V, 1-5 V, and ± 10 V Inputs
- Large Dual-Line 6-Digit Display, 0.60" & 0.46"
- Optional SunBright Display Models for Outdoor Applications
- NEMA 4X, IP65 Front
- Input Power Options Include 85-265 VAC or 12-24 VDC
- Isolated 24 VDC @ 200 mA Transmitter Power Supply
- Programmable Display & Function Keys
- 32-Point, Square Root, or Exponential Linearization
- Multi-Pump Alternation Control
- 2 or 4 Relays + Isolated 4-20 mA Output Options
- External 4-Relay & Digital I/O Expansion Modules
- RS-232, & RS-485 Serial Communication Options
- Modbus® RTU Communication Protocol Standard
- On-Board Digital Input
- Onboard USB and MeterView® Pro Programming Software

PD6060 ProVu® Dual-Input Process Meter



UV Resistant
Sunlight Readable Models



Front Panel
NEMA 4X Rated



MeterView Pro

USB Install



Large
0.6" Digits

Rugged Front

Dual-Line
6-Character
Display

User Configurable
Display (Showing
custom tag)

User Configurable
Display (Showing
math function result)

Programmable
Function Keys

Alarm
Status Indicators

ADVANCED, VERSATILE, & CUSTOMIZABLE

The PD6060 meter combines two independently programmed analog inputs with powerful math functions to make an advanced meter capable of handling complex math requirements common in the process industry. Various math functions may be applied to the inputs including addition, difference, average, multiplication, division, ratio, and more. A customizable dual-line display allows a wide variety of input variables, math calculations, or units and tags to be displayed based on your application needs.

KEY FEATURES

The PD6060 meter is the mathematician of the ProVu family. Its two process input channels and math functions make it unique while still maintaining all the great features of the ProVu family.

Dual-Input Process Meter

The PD6060 has two process input channels (A & B) capable of accepting current (0-20, 4-20 mA) and voltage (± 10 , 0-5, 1-5, 0-10 VDC). Each input is programmed separately, with independent input type selection and scaling. These inputs may be displayed individually as part of the customizable dual-line display, or used with a wide range of math functions. Each input has a custom unit or tag that may be displayed. A 24 V transmitter power supply is standard and may be used to power the inputs.

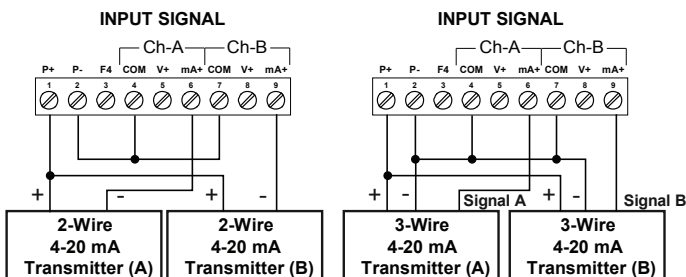

Powerful Math Functions

The PD6060 uses two process input channels (A & B) in a variety of powerful math functions designed for a wide range of process applications. Programmable adder (P) and factor (F) constants allow each formula to be customized as needed for a specific application. The math function (C) may be displayed with units, tags, channel A or B, and in other useful combinations.

Name	Function	Setting
Addition	$(A+B+P)*F$	Sum
Difference	$(A-B+P)*F$	dif
Absolute diff.	$((\text{Abs}(A-B))+P)*F$	difABS
Average	$((A+B)/2+P)*F$	Avg
Multiplication	$((A*B)+P)*F$	mult
Divide	$((A/B)+P)*F$	dive
Max of A or B	$((\text{AB-Hi})+P)*F$	Hi-AB
Min of A or B	$((\text{AB-Lo})+P)*F$	Lo-AB
Draw	$((A/B)-1)*F$	draw
Weighted Avg.	$((B-A)*F)+A$	W.Avg
Ratio	$(A/B)*F$	rAt
Ratio 2	$((B-A)/A+P)*F$	rAt2
Concentration	$(A/(A+B))*F$	ConcEn

Note: The F constant can be any value from 0.00001 to 999999. If the value is less than 1, it will have the same effect as a divider. For example, the average could also be derived by using $(A+B)*F$, where $F = 0.500$.

Configurable

The upper display can be programmed to indicate PV, maximum (peak), minimum (valley), alternating maximum/minimum, one of eight alarm set points, or Modbus input. The lower display can also be configured to display engineering units, set points, user defined legends, or simply turned off.

Max/Min Display

Max/Min (or Peak/Valley) is standard on the ProVu PD6060. Either display can be configured to show either input's maximum or minimum value since last reset. The displays can also be configured to toggle between Max and Min values. Both values can be simply reset from the front panel.

PD6060 PROVu® Dual-Input Process Meter

Customizable Displays

The PROVu has two red LED displays, an Upper display 0.60" (15 mm) high, and a Lower display 0.46" (12 mm) high. Each display is a full 6 digits (-99999 to 999999).

The displays can be set up to read input channels (A or B), math function channel C, toggle between A & B, B & C, A & C, A & B & C, toggle between channels A, B, or C & units, the max/min of any of the channels, including the math channel (C), set points, gross (without tare) or net (with tare) & gross values of channel A or B, or the Modbus input. This allows the display to be setup to display whatever variables are most valuable to the application. Here are just a few examples.



Math Function & Tag

The Upper display shows the math function result (C). The Lower display shows a custom label, in this case the math function used.



Math Function & Inputs A & B

The Upper display shows the math function result (C). The Lower display alternates between channels A and B, with an indicator for each when being displayed.



Input Channels A & B

Both input channels are displayed, input A on the Upper display and input B on the Lower display. Indicators show A or B to label the display.

Alternation Display

Certain display options alternate the display information. A single display can show input variable information as well as that channel's unit or tag. Input and math function channels, gross and net values, and select inputs and the math result may also alternate on a single display. Below are just a few of the options for setting up a single display to alternate information.



Lower Display Alternating Input Channels A & B



Both Displays Alternating Input Value and Unit

METERVIEW® PRO SOFTWARE

Configure, monitor, and datalog a PD6001 from a PC using Meter View Pro Software (available with each PROVu meter via USB or for download at www.predig.com).

Standard LED and Optional SunBright LED Display Models

The PROVu's standard and SunBright display models feature extraordinarily bright LED displays. They are perfect for indoor and outdoor applications where visibility may be impaired by smoke, fog, dust, or distance. The intensity on the SunBright display model is so high it can be read even in the brightest sunlight.

Function Keys

There are three function keys available to the user. These keys can be programmed to trigger certain events (i.e. acknowledge alarms, reset max and/or min, disable/enable output relays, or hold current relay states), provide direct menu access points, and more.

Learn more about using the PROVu's Function Keys by watching a video at predig.com/videos

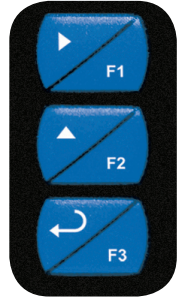

Free USB Programming Software & Cable

The PROVu® comes preloaded with free **MeterView® Pro** programming software that connects and installs directly to your PC with a standard USB cable, also provided free with each instrument. This eliminates the need to insert CDs, install drivers, or download software from the internet. The software will allow you to configure, monitor, and datalog a PROVu® PD6060 using your PC. Just simply connect the meter to your PC with the USB cable and within minutes you will be programming it.

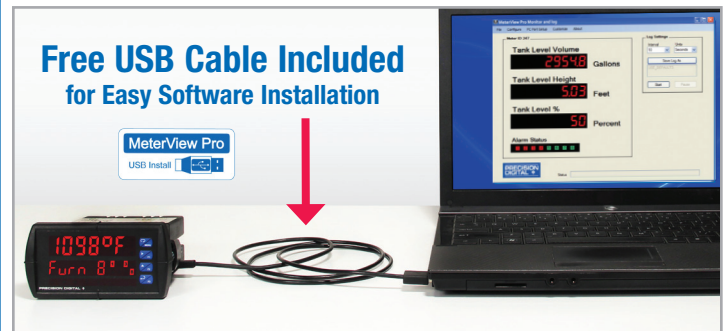

Rugged

A unique front panel design makes the PROVu nearly impenetrable in typical applications. Here, the PROVu easily survives a direct hit on the display from a heavy 2" solid stainless steel ball dropped from eight feet.

Easy to Use

The user friendly dual-line display makes the PROVu easy to set up & program. No jumpers to set for input selection. All setup & programming are done via the front panel. Three levels of password protection help maintain the reliability of the programming.



Input Setup



Display Setup

PD6060 PROVU® Dual-Input Process Meter

Three Tier Password Protection

The PROVU offers 3 levels of password protection:

- Level 1 protection allows the operator use of only the 3 pre-configured function keys on the front panel without a password.
- Level 2 protection allows the operator use of only the function keys and the ability to change set points without a password.
- Level 3 protection restricts the operator from using the function keys and all meter configuration menus without a password.

Advanced Linearization Capability

The PROVU includes a 32-point linearizer for each input. In non-linear level applications (i.e. some pumping or lift stations), it can easily compensate for submerged equipment or plumbing that displace usable volume. In addition to the 32-point linearization, the PROVU can perform a square root or programmable exponent function on one or both inputs, or automatically calculate level in round horizontal tanks by inputting the length and height of the tank. Each input's linearization is performed independently prior to the input value being used in any math function. Precision Digital's free MeterView Pro PC-based software greatly simplifies the construction of the linearization tables. The software can save this data to the meter and/or PC.

On-Board Digital Input

The PD6060 includes a digital input as standard. This digital input can operate with the tare, reset tare, or interlock relays feature, force relays on from a signal from a PLC or relay on other equipment, and much more. This is ideal for installations where the meter is inaccessible behind a cover, or where an additional function key is needed for customized operation.

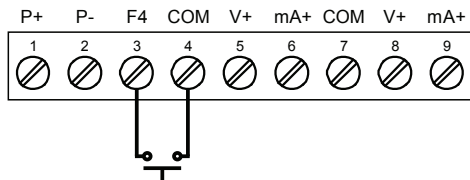

Rounding

The rounding feature is used to give the user a steadier display with fluctuating signals. It causes the display to round to the nearest value according to the rounding value selected (1, 2, 5, 10, 20, 50, or 100). For example, with a rounding value of 10, and an input of 12346, the display would indicate 12350.

DIGITAL COMMUNICATIONS

Modbus® RTU Serial Communications

With the purchase of a serial communication adapter, PROVU meters can communicate with any Modbus Master device using the ever-popular Modbus communications protocol that is included in every PROVU. This greatly increases the flexibility of the meter. Modbus provides much more capability than read PV and write set points.



Modbus PV Input



Remote Message

FIELD EXPANSION MODULES

Add functionality to the PROVU in the field with easy-to-install external expansion modules. Add USB, RS-232, or RS-485 communications, I/O modules (up to 2), and 4-relay expansion module. The menu items for these modules do not appear until the module is connected, simplifying the basic menu. Relay and digital I/O modules are shown below with optional DIN rail mounting kit, P/N PDA1002.

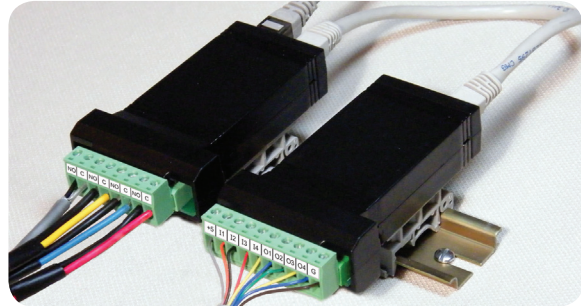

PDA1044 I/O Expansion Module

Four digital inputs and four digital outputs are available per expansion module. The PROVU meter will accept two of these modules. External digital inputs can function similarly to the front panel function keys or on-board digital input F4. They can be configured to trigger certain events (i.e. acknowledge/reset alarms, reset max and/or min values, disable/enable all output relays, and hold current relay states), provide direct menu access point, or mimic front panel keys. The I/O module can be used to configure the PROVU remotely, in essence giving the user control of the four front panel push buttons. This feature is particularly useful if the meter is mounted inside an explosion-proof enclosure.

Digital outputs can be used to remotely monitor PROVU's alarm relay output states, or the states of a variety of actions and functions executed by the meter.

PDA1004 Relay Expansion Module

An external module containing four 3 A Form A (SPST) relays can be added to the PROVU at anytime. Removable screw terminal blocks accept 12 to 22 AWG wire.

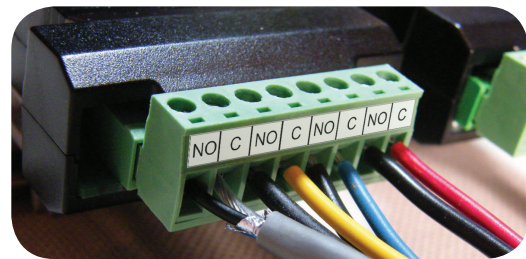

PDA1232 & PDA1485 Communication Modules

Serial communications on the PROVU can be added anytime with external PDA1232 (RS-232) or PDA1485 (RS-485) communication adapters.

Free Modbus protocol included for use with PROVU serial communications modules.



OUTPUTS

Relay Outputs

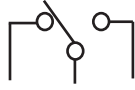

The PROVu has up to four 3 A Form C relays (SPDT) with multiple power loss fail-safe options. Each relay may be assigned to input channel A or B, or math result (C). Relays can be configured for proper protective action upon input loop break. Relay ON and OFF delay times are user adjustable. Up to eight front panel indicators show alarm and/or relay state. All relays can be configured for 0-100% deadband.

Relay Operation/Configuration

There are powerful relay functions that can be configured in the PROVu meter, including:

- Automatic reset only (non-latching)
- Automatic + manual reset at any time (non-latching)
- Latching (manual reset only)
- Latching with clear (manual reset only after alarm condition has cleared)
- Pump alternation control (automatic reset only)
- Sampling (activated for a user-specified time)
- User selectable fail-safe operation
- Relay action for loss (break) of 4-20 mA input signal
- Time delay (on and off), independent for each relay
- Manual control mode
- Interlock relay mode

Analog Output

The isolated analog retransmission signal can be configured to represent process input channel A or B, math result (C), max or min for channel A, B, or highest or lowest max or min of A and B, set points 1-8, Modbus input, or manual control mode. While the output is nominally 4-20 mA, the signal will accurately accommodate under- and over-ranges from 1 to 23 mA.

Manual Output Control

Take control of any output with this feature. All relays can be forced ON or OFF, and the 4-20 mA output signal can be set to any value within its range. When the relays and 4-20 mA output are controlled manually, an LED labeled “M” is turned on and the associated Alarm LEDs (1-8) flash every 10 seconds indicating that the meter is in manual control mode.



Isolated Transmitter Power Supplies

A powerful 24 V @ 200 mA power supply is a standard feature on the PROVu meter. It can be configured for 5, 10, or 24 V (default) by means of a simple internal jumper (see manual). An additional power supply (24 V @ 40 mA) is standard with the 4-20 mA output option.

Sampling Function (PV Triggered Timed Relay)

The sampling function allows the operator to set a set point for a “sampling” relay. The relay can be assigned to input channels A or B, or the math result (C). When the PV reaches that set point, it will close that relay’s contacts for a preset period of time (0.1 to 5999.9 seconds). An example of its use may be for beer/ale fermentation. When the batch reaches a certain pH, the relay contacts would close and alert someone or automatically take a sample of the batch. This function can be used whenever a timed relay output closure is required when the PV reaches a certain set point.

Interlock Relay(s)

This function allows a process to use one or more very low voltage input signals or simple switch contacts to control the state of one or more internal “interlock” relays. A violation (i.e. loss of input, open switch, or open circuit) forces one or more N/O interlock relay contacts to open. One input can be used in series with a number of interlock switches, or up to eight inputs can be required to force-on one (or more) internal interlock relays. Please see *ProVu Series Safety Interlock Feature* white paper on our website for more information. Requires PDA1044 Digital I/O module or use of on-board digital input F4.

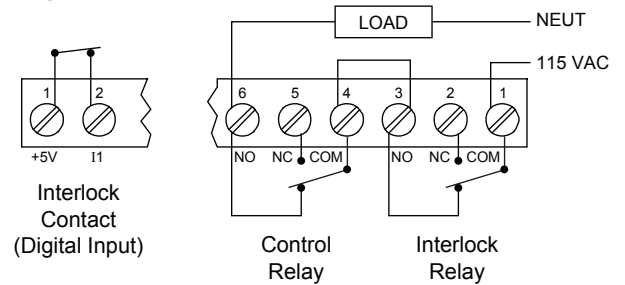

SIGNAL INPUT CONDITIONING

Non-linear input signals (i.e. weirs & flumes, differential pressure, etc.) can be linearized with the PROVu’s simple to use built-in signal input conditioning, such as: square-root extractor, exponential linearizer, horizontal round tank linearizer, or the PROVu powerful general purpose 32-point linearizer.

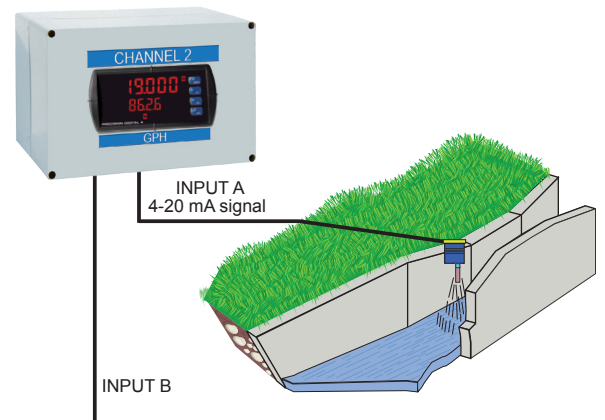

Weir Flow Calculated Using Exponential Signal Input Conditioning

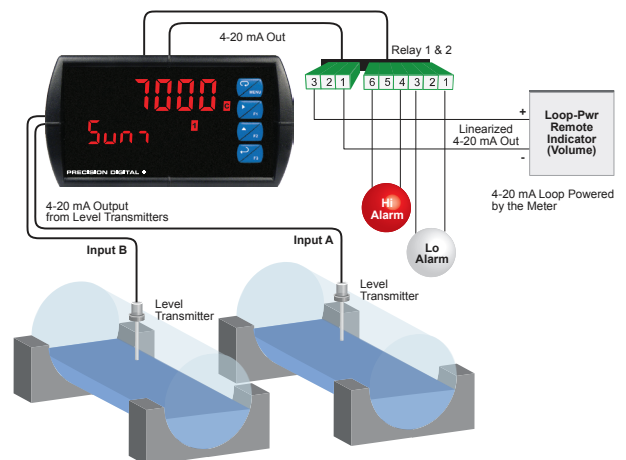

Round Horizontal Tank Signal Input Conditioning

PD6060 ProVu® Dual-Input Process Meter

Multi-Pump Alternation

Up to 8 pumps can be alternated/sequenced.

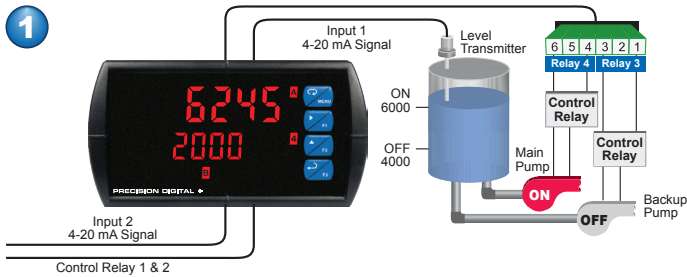

Relay #4 turns the main pump on at 6000 gallons and turns it off at 1000 gallons.

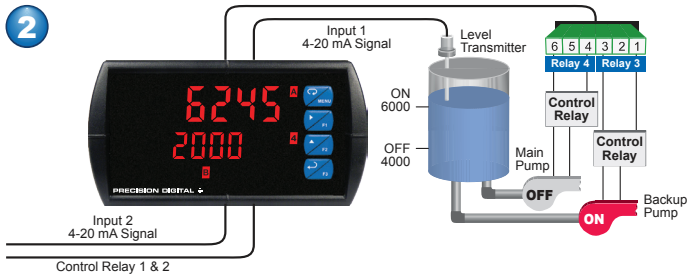

With the Pump Alternation feature activated, the next time the level reaches 6000 gallons, relay #3 transfers and starts the backup pump.

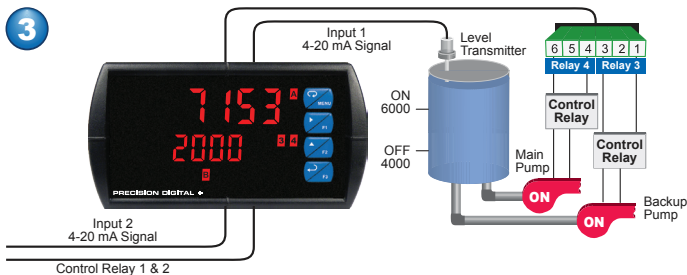

If the backup pump is not able to keep up, and the level reaches 7000 gallons, relay #4 transfers and starts the main pump as well.

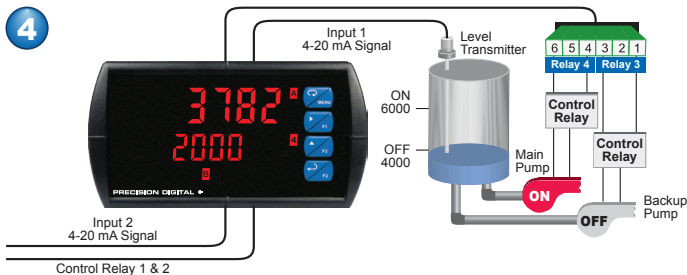

At 4000 gallons, relay 3 turns off and the system returns to normal pump alternation control.

PROTEX-MAX EXPLOSION-PROOF



All the proven features of the ProVu brought into your hazardous areas! Go to www.predig.com/pd8

PD8-6000
ProtEX-MAX Explosion-Proof

NEMA 4 & 4X FIELD ENCLOSURES

Precision Digital offers a variety of rugged enclosures that provide a high degree of protection against harsh operating environments. Thermoplastic and stainless steel NEMA 4X, and painted steel NEMA 4 enclosures for up to 10 ProVu meters are available.



PDA2811 Plastic Low-Cost **PDA2302** Plastic Economical **PDA2604** Stainless Steel

See our complete offering at www.predig.com/esu

DIMENSIONS

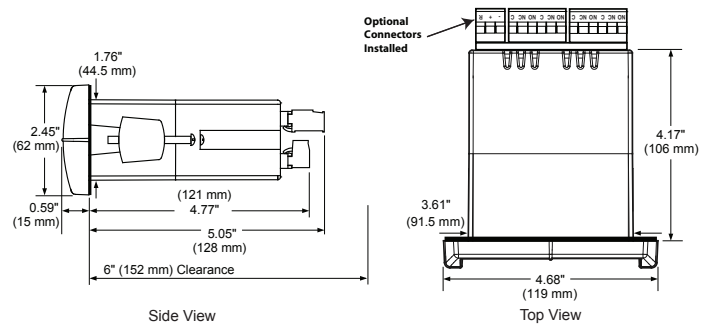

Notes:

1. Panel cutout required: 1.772" x 3.622" (45 mm x 92 mm)
2. Panel thickness: 0.040 - 0.250" (1.0 mm - 6.4 mm)
3. Mounting brackets lock in place for easy mounting
4. Clearance: Allow 6" (152 mm) behind the panel

CONNECTIONS

- Form C (SPDT) relays
- Two isolated supplies available even on 12/24 VDC input power models
- Removable terminal blocks
- 2 or 4 relays + isolated 4-20 mA output option

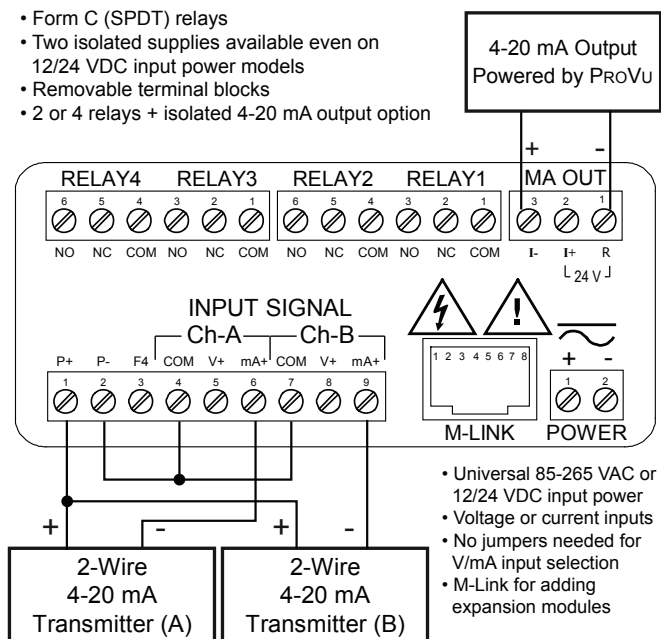

- Universal 85-265 VAC or 12/24 VDC input power
- Voltage or current inputs
- No jumpers needed for V/mA input selection
- M-Link for adding expansion modules

SPECIFICATIONS

Except where noted all specifications apply to operation at +25°C.

General

Display: Upper display: 0.60" (15 mm) high. Lower display: 0.46" (12 mm) high. Both are 6 digits (-99999 to 999999), red LEDs

Display Intensity: Eight user selectable intensity levels

Display Update Rate: 5/second (200 ms)

Overrange: Display flashes 999999

Underrange: Display flashes -99999

Display Assignment: The Upper and Lower displays may be assigned to process values for Channels A (Ch-A), B (Ch-B), or C (Ch-C), toggle between (Ch-A & Ch-B, Ch-A & Ch-C, Ch-B & Ch-C, and Ch-A, Ch-B, & Ch-C), toggle between Channel & units, show channel gross value (no tare) or toggle net (tare) and gross values, show relay set points, max & min values, or Modbus input. The second display may also be set to show engineering units or be off, with no display.

Front Panel: NEMA 4X, IP65

Programming Methods: Four front panel buttons, digital inputs, PC and MeterView Pro software, Modbus registers, or cloning using Copy function.

F4 Digital Input Contacts: 3.3 VDC on contact. Connect normally open contacts across F4 to COM.

F4 Digital Input Logic Levels: Logic High: 3 to 5 VDC

Noise filter: Programmable from 2 to 199 (0 will disable filter)

Filter Bypass: Programmable from 0.1 to 99.9% of calibrated span

Recalibration: All ranges are calibrated at the factory. Recalibration is recommended at least every 12 months.

Max/Min Display: Max (Peak) / min (Valley) readings reached by the process are stored until reset by the user or until power to the meter is cycled.

Password: Three programmable passwords restrict modification of programmed settings.

Non-Volatile Memory: All programmed settings are stored in non-volatile memory for a minimum of ten years if power is lost.

Power Options: 85-265 VAC 50/60 Hz, 90-265 VDC, 20 W max, or optional model with 12-24 VDC $\pm 10\%$, 15 W max.

Fuse: Required external fuse: UL Recognized, 5 A max, slow blow; up to 6 meters may share one 5 A fuse.

Isolated Transmitter Power Supply: Terminals P+ & P-: 24 VDC $\pm 10\%$. Internally selectable jumper for 24, 10, or 5 VDC supply.

85-265 VAC models rated @ 200 mA max, 12-24 VDC powered models rated @ 100 mA max, @ 50 mA max for 5 or 10 VDC supply.

Normal Mode Rejection: Greater than 60 dB at 50/60 Hz

Isolation: 4 kV input/output-to-power line. 500 V input-to-output or output-to-P+ supply.

Overvoltage Category: Installation Overvoltage Category II: Local level with smaller transient overvoltages than Installation Overvoltage Category III.

Environmental: Operating temperature range: -40 to 65°C

Storage temperature range: -40 to 85°C

Relative humidity: 0 to 90% non-condensing

Connections: Removable screw terminal blocks accept 12 to 22 AWG wire, RJ45 for external relays, digital I/O, and serial communication adapters.

Enclosure: 1/8 DIN, high impact plastic, UL 94V-0, color: black

Mounting: 1/8 DIN panel cutout required: 3.622" x 1.772"

(92 mm x 45 mm). Two panel mounting bracket assemblies are provided.

Tightening Torque: Screw terminal connectors: 5 lb-in (0.56 Nm)

Overall Dimensions: 4.68" x 2.45" x 5.64"

(119 mm x 62 mm x 143 mm) (W x H x D)

Weight: 9.5 oz (269 g)

UL File Number: UL & c-UL Listed. E160849; 508 Industrial Control Equipment.

Warranty: 3 years parts & labor

USB Connection: Compatibility: USB 2.0 Standard, Compliant Connector Type: Micro-B receptacle

Cable: USB A Male to Micro-B Cable

Driver: Windows 98/SE, ME, 2000, Server 2003/2008, XP 32/64-Bit,

Vista 32/64-Bit, Windows 7 32/64-Bit, Windows 10 32/64-Bit

Power: USB Port

Dual Process Input

Inputs: Two non-isolated inputs, each separately field selectable: 0-20, 4-20 mA, 10 V (0-5, 1-5, 0-10 V), Modbus PV (Slave)

Channels: Channel A, Channel B, Channel C (Math channel)

Programmable Constants: Constant P (Adder): -99999 to 999999, default: 0.000; Constant F (Factor): 0.00001 to 999999, default: 1.000

Math Functions: Addition, difference, absolute difference, average, multiplication, division, max of A or B, min of A or B, draw, weighted average, ratio, concentration. See instruction manual for details.

Sequence of Operations for Input Programming:

1. Select Input for A and B
2. Set up the engineering units for A, B, and C
3. Set up decimal point for A, B, and C
4. Scale A & B
5. Set up the displays for A, B, or C
6. Select the transfer function for A & B (e.g. Linear)
7. Select Math function for Channel C
8. Program constants for Factor (F) and Adder (P).
9. Program cutoff values for A and B

Accuracy: $\pm 0.03\%$ of calibrated span ± 1 count, square root & programmable exponent accuracy range: 10-100% of calibrated span

Temperature Drift: 0.005% of calibrated span/ $^{\circ}$ C max from 0 to 65°C ambient, 0.01% of calibrated span/ $^{\circ}$ C max from -40 to 0°C ambient

Signal Input Conditioning: Linear, square root, programmable exponent, or round horizontal tank volume calculation.

Multi-Point Linearization: 2 to 32 points for channel A and B

Programmable Exponent: 1.0001 to 2.9999

Low-Flow Cutoff: 0-999999 (0 disables cutoff function)

Decimal Point: Up to five decimal places or none: *d.ddddd*, *dd.dddd*, *ddd.ddd*, *dddd.dd*, *ddddd.d*, or *dddddd*.

Calibration Range: 4-20 mA: minimum span input 1 & input 2: 0.15 mA. ± 10 V: minimum span input 1 & 2: 0.10 V. An Error message will appear if input 1 and input 2 signals are too close together.

Input Impedance: Voltage ranges: greater than 500 k Ω . Current ranges: 50 - 100 Ω (depending on resettable fuse impedance).

Input Overload: Current input protected by resettable fuse, 30 VDC max. Fuse resets automatically after fault is removed.

Relays

Rating: 2 or 4 SPDT (Form C) internal and/or 4 SPST (Form A) external; rated 3 A @ 30 VDC and 125/250 VAC resistive load; 1/14 HP (\approx 50 W) @ 125/250 VAC for inductive loads.

Noise Suppression: Noise suppression is recommended for each relay contact switching inductive loads.

Deadband: 0-100% of span, user programmable

High or Low Alarm: User may program any alarm for high or low trip point. Unused alarm LEDs and relays may be disabled (turned off).

Relay Operation: automatic (non-latching), latching (requires manual acknowledge), sampling (based on time), pump alternation control (2 to 8 relays), Off (disable unused relays and enable interlock feature, manual on/off control mode).

Relay Reset: User selectable via front panel buttons or digital inputs.

1. Automatic reset only (non-latching), when input passes the reset point.
2. Automatic + manual reset at any time (non-latching).
3. Manual reset only, at any time (latching).
4. Manual reset only after alarm condition has cleared (latching).

Note: Front panel button or digital input may be assigned to acknowledge relays programmed for manual reset.

Time Delay: 0 to 999.9 seconds, on & off relay time delays. Programmable and independent for each relay.

Fail-Safe Operation: Programmable and independent for each relay. *Note: Relay coil is energized in non-alarm condition. In case of power failure, relay will go to alarm state.*

Auto Initialization: When power is applied to the meter, relays will reflect the state of the input to the meter.

PD6060 ProVu® Dual-Input Process Meter

Serial Communications

Protocol: Modbus® RTU

Meter Address/Slave ID: 1 - 247

Baud Rate: 300 - 19,200 bps

Transmit Time Delay: Programmable between 0 and 199 ms

Data: 8 bit (1 start bit, 1 or 2 stop bits)

Parity: Even, odd, or none with 1 or 2 stop bits

Byte-to-Byte Timeout: 0.01 - 2.54 seconds

Turn Around Delay: Less than 2 ms (fixed)

Note: Refer to the ProVu® Modbus Register Tables located at www.predig.com for details.

Isolated 4-20 mA Transmitter Output

Output Source: Process channel A, B, or C, max or min for channel A, B, or highest or lowest max or min of A and B, set points 1-8, Modbus input, or manual control mode

Scaling Range: 1.000 to 23.000 mA for any display range

Calibration: Factory calibrated: 4.000 to 20.000 = 4-20 mA output

Analog Output Programming: 23.000 mA maximum for all parameters: Overrange, underrange, max, min, and break

Accuracy: ± 0.1% of span ± 0.004 mA

Temperature Drift: 0.4 µA/°C max from 0 to 65°C ambient, 0.8 µA/°C max from -40 to 0°C ambient

Note: Analog output drift is separate from input drift.

Isolated Transmitter Power Supply: Terminals I+ & R: 24 VDC ± 10%. Isolated from the input at >500 V. May be used to power the 4-20 mA output or other devices. All models rated @ 40 mA max.

External Loop Power Supply: 35 VDC maximum

Output Loop Resistance:

Power supply	Minimum	Maximum
24 VDC	10 Ω	700 Ω
35 VDC (external)	100 Ω	1200 Ω

Digital I/O Expansion Module

Channels: 4 digital inputs & 4 digital outputs per module

System: Up to 2 modules for a total of 8 inputs & 8 outputs

Digital Input Logic: High: 3 to 5 VDC **Low:** 0 to 1.25 VDC

Digital Output Logic: High: 3.1 to 3.3 VDC **Low:** 0 to 0.4 VDC

Source Current: 10 mA maximum

Sink Current: 1.5 mA minimum

+5 V Terminal: To be used as pull-up for digital inputs only.

4-Relay Expansion Module

Relays: Four Form A (SPST) rated 3 A @ 30 VDC and 125/250 VAC resistive load; 1/14 HP (≈ 50 watts) @ 125/250 VAC for inductive loads.

Disclaimer

The information contained in this document is subject to change without notice. Precision Digital Corporation makes no representations or warranties with respect to the contents hereof, and specifically disclaims any implied warranties of merchantability or fitness for a particular purpose.

©2011-2017 Precision Digital Corporation. All rights reserved.

ORDERING INFORMATION

ProVu® PD6060 • Standard Models		
85-265 VAC Model	12-24 VDC Model	Options Installed
PD6060-6R0	PD6060-7R0	None
PD6060-6R2	PD6060-7R2	2 Relays
PD6060-6R3	PD6060-7R3	4-20 mA Output
PD6060-6R4	PD6060-7R4	4 Relays
PD6060-6R5	PD6060-7R5	2 Relays & 4-20 mA Output
PD6060-6R7	PD6060-7R7	4 Relays & 4-20 mA Output

Note: 24 V Transmitter power supply standard on all models.

ProVu® PD6060 • SunBright Display Models		
85-265 VAC Model	12-24 VDC Model	Options Installed
PD6060-6H0	PD6060-7H0	None
PD6060-6H2	PD6060-7H2	2 Relays
PD6060-6H3	PD6060-7H3	4-20 mA Output
PD6060-6H4	PD6060-7H4	4 Relays
PD6060-6H5	PD6060-7H5	2 Relays & 4-20 mA Output
PD6060-6H7	PD6060-7H7	4 Relays & 4-20 mA Output

Note: 24 V Transmitter power supply standard on all models.

Accessories	
Model	Description
PDA1002	DIN Rail Mounting Kit for Two Expansion Modules
PDA1004	4-Relay Expansion Module
PDA1011	Dual 4-20 mA Output Module
PDA1044	4 Digital Inputs & 4 Digital Outputs Module
PDA1232	RS-232 Serial Adapter
PDA1485	RS-485 Serial Adapter
PDA7485-I	RS-232 to RS-422/485 Isolated Converter
PDA7485-N	RS-232 to RS-422/485 Non-Isolated Converter
PDA8232-N	USB to RS-232 Non-Isolated Converter
PDA8485-I	USB to RS-422/485 Isolated Converter
PDA8485-N	USB to RS-422/485 Non-Isolated Converter
PDX6901	Suppressor (snubber): 0.01 µF/470 Ω, 250 VAC

Your Local Distributor is: