

SINEAX DME 424/442

Programmable Multi-Transducers

for the measurement of electrical variables in heavy-current power systems



Application

The **SINEAX DME 4** series of multi-transducers (Fig. 1) **simultaneously** measure several variables of an electric power system and process them to produce 2 resp. 4 analog output signals.

2 or 4 digital outputs are available for signalling limits or energy metering. For two of the limit outputs up to three measurands can be logically combined.

The multi-transducers are also equipped with an **RS 232** serial interface to which a PC with the corresponding software can be connected for programming and accessing and executing useful ancillary functions.

The usual modes of connection, the types of measured variables, their ratings, the transfer characteristic for each output etc. are the main parameters that have to be programmed.

Ancillary functions include a power system check, provision for displaying the measured variably on a PC monitor, the simulation of the outputs for test purposes and a facility for printing name-plates.

The transducer fulfils all the essential requirements and regulations concerning electromagnetic compatibility (**EMC**) and **safety** (IEC 1010 resp. EN 61 010). It was developed and is manufactured and tested in strict accordance with the **quality assurance standard** ISO 9001.

Features / Benefits

- Simultaneous measurement of several variables of a heavy-current power system / Full supervision of an asymmetrically loaded four-wire power system, rated current 1 to 6 A, rated voltage 57 to 400 V (phase-to-neutral) or 100 to 693 V (phase-to-phase)
- Input voltage up to 693 V (phase-to-phase)
- Universal analog outputs (programmable)
- High accuracy: U/I 0.2%, P 0.25% (under reference conditions)
- Universal digital outputs (meter transmitter, limits)
- Up to 2 or 4 integrated energy meters, storage every each 203 s, storage for: 20 years
- Windows software with password protection for programming, data analysis, power system status simulation, acquisition of meter data and making settings
- AC/DC power supply / Universal
- Provision for either snapping the transducer onto top-hat rails or securing it with screws to a wall or panel

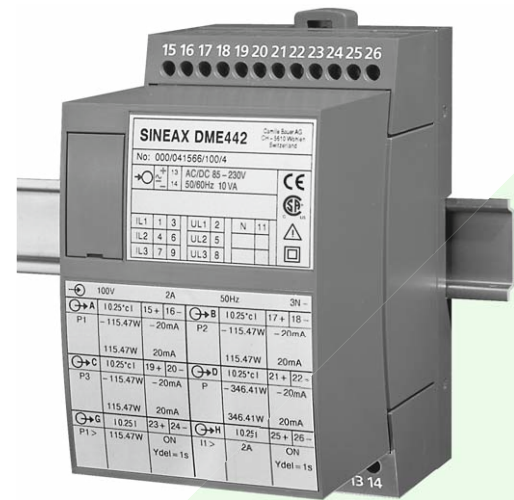

Fig. 1. The **universal** basic version SINEAX DME 442 in housing **T24**, clipped onto a top-hat rail.

Measured variables	Output	Types
Current, voltage (rms), active/reactive/apparent power $\cos\phi$, $\sin\phi$, power factor RMS value of the current with wire setting range (bimetal measuring function) Slave pointer function for the measurement of the RMS value IB Frequency Average value of the currents with sign of the active power (power system only)	2 analog outputs and 4 digital outputs or 4 analog outputs and 2 digital outputs	DME 424 DME 442
	Data bus LON see data sheet DME 400-1 Le	DME 400
	4 analog outputs and bus RS 485 (MODBUS) see data sheet DME 440-1 Le	DME 440
	Without analog outputs, with bus RS 485 (MODBUS) see data sheet DME 401-1 Le	DME 401
	PROFIBUS DP see data sheet DME 406-1 Le	DME 406

SINEAX DME 424/442

Programmable Multi-Transducers

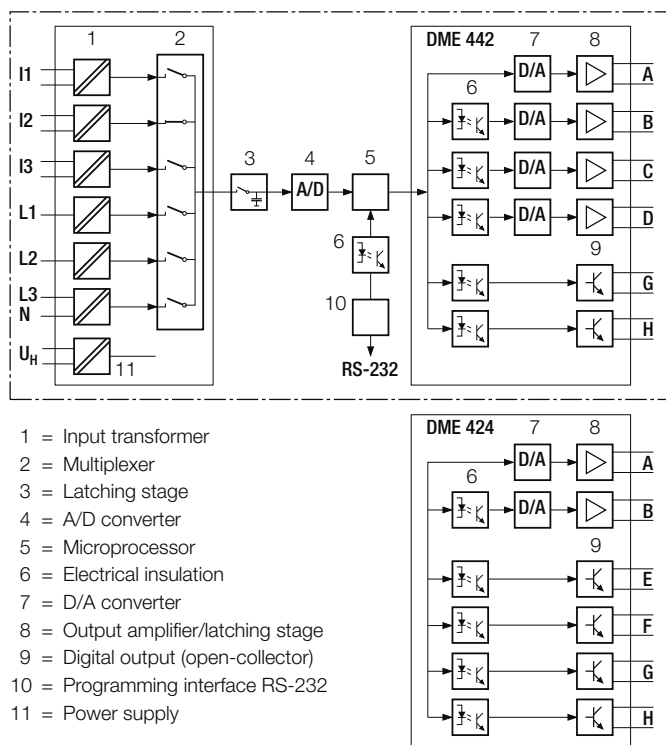

Fig. 2. Block diagram.

A, B, C, D = analog outputs; E, F, G, H = digital outputs.

Symbols

Symbols	Meaning
X	Measured variable
X0	Lower limit of the measured variable
X1	Break point of the measured variable
X2	Upper limit of the measured variable
Y	Output variable
Y0	Lower limit of the output variable
Y1	Break point of the output variable
Y2	Upper limit of the output variable
U	Input voltage
Ur	Rated value of the input voltage
U 12	Phase-to-phase voltage L1 – L2
U 23	Phase-to-phase voltage L2 – L3
U 31	Phase-to-phase voltage L3 – L1
U1N	Phase-to-neutral voltage L1 – N
U2N	Phase-to-neutral voltage L2 – N
U3N	Phase-to-neutral voltage L3 – N
UM	Average value of the voltages (U1N + U2N + U3N) / 3

Symbols	Meaning
I	Input current
I1	AC current L1
I2	AC current L2
I3	AC current L3
Ir	Rated value of the input current
IM	Average value of the currents (I1 + I2 + I3) / 3
IMS	Average value of the currents and sign of the active power (P)
IB	RMS value of the current with wire setting range (bimetal measuring function)
IBT	Response time for IB
BS	Slave pointer function for the measurement of the RMS value IB
BST	Response time for BS
φ	Phase-shift between current and voltage
F	Frequency of the input variable
Fn	Rated frequency
P	Active power of the system $P = P1 + P2 + P3$
P1	Active power phase 1 (phase-to-neutral L1 – N)
P2	Active power phase 2 (phase-to-neutral L2 – N)
P3	Active power phase 3 (phase-to-neutral L3 – N)
Q	Reactive power of the system $Q = Q1 + Q2 + Q3$
Q1	Reactive power phase 1 (phase-to-neutral L1 – N)
Q2	Reactive power phase 2 (phase-to-neutral L2 – N)
Q3	Reactive power phase 3 (phase-to-neutral L3 – N)
S	Apparent power of the system $S = \sqrt{I_1^2 + I_2^2 + I_3^2} \cdot \sqrt{U_1^2 + U_2^2 + U_3^2}$
S1	Apparent power phase 1 (phase-to-neutral L1 – N)
S2	Apparent power phase 2 (phase-to-neutral L2 – N)
S3	Apparent power phase 3 (phase-to-neutral L3 – N)
Sr	Rated value of the apparent power of the system
PF	Active power factor $\cos\varphi = P/S$
PF1	Active power factor phase 1 $P1/S1$
PF2	Active power factor phase 2 $P2/S2$
PF3	Active power factor phase 3 $P3/S3$
QF	Reactive power factor $\sin\varphi = Q/S$
QF1	Reactive power factor phase 1 $Q1/S1$
QF2	Reactive power factor phase 2 $Q2/S2$

SINEAX DME 424/442

Programmable Multi-Transducers

Symbols	Meaning
QF3	Reactive power factor phase 3 Q3/S3
LF	Power factor of the system $LF = \text{sgn}Q \cdot (1 - PF)$
LF1	Power factor phase 1 $\text{sgn}Q1 \cdot (1 - PF1)$
LF2	Power factor phase 2 $\text{sgn}Q2 \cdot (1 - PF2)$
LF3	Power factor phase 3 $\text{sgn}Q3 \cdot (1 - PF3)$
c	Factor for the intrinsic error
R	Output load
Rn	Rated burden
H	Power supply
Hn	Rated value of the power supply
CT	c.t. ratio
VT	v.t. ratio

Applicable standards and regulations

EN 60 688	Electrical measuring transducers for converting AC electrical variables into analog and digital signals
IEC 1010 or EN 61 010	Safety regulations for electrical measuring, control and laboratory equipment
EN 60529	Protection types by case (code IP)
IEC 255-4 Part E5	High-frequency interference test (solid-state relays only)
IEC 1000-4-2, 3, 4, 6	Electromagnetic compatibility for industrial process measurement and control equipment
VDI/VDE 3540, page 2	Reliability of measuring and control equipment (classification of climates)
DIN 40 110	AC quantities
DIN 43 807	Terminal markings
IEC 68 /2-6	Basic environmental testing procedures, vibration, sinusoidal
EN 55011	Electromagnetic compatibility of data processing and telecommunication equipment
	Limits and measuring principles for radio interference and information equipment
IEC 1036	Solid state AC watt hour meters for active power (classes 1 and 2)
DIN 43864	Current interface for the transmission of impulses between impulse encoder counter and tarif meter
UL 94	Tests for flammability of plastic materials for parts in devices and appliances

Technical data

Inputs

Input variables:	See Table 2, 3 and 4
Measuring ranges:	See Table 2, 3 and 4
Waveform:	Sinusoidal
Rated frequency:	50...60 Hz; 16 2/3 Hz
Consumption:	Voltage circuit: $\leq U^2 / 400 \text{ k}\Omega$ Condition: external power supply Current circuit: $0.3 \text{ VA} \cdot I/5 \text{ A}$

Continuous thermal ratings of inputs

Current circuit	10 A	400 V single-phase AC system 693 V three-phase system
Voltage circuit	480 V 831 V	single-phase AC system three-phase system

Short-time thermal rating of inputs

Input variable	Number of inputs	Duration of overload	Interval between two overloads
Current circuit 400 V single-phase AC system 693 V three-phase system			
100 A	5	3 s	5 min.
250 A	1	1 s	1 hour
Voltage circuit 1 A, 2 A, 5 A			
Single-phase AC system 600 V $H_{\text{intern}}: 1.5 U_r$	10	10 s	10 s
Three-phase system 1040 V $H_{\text{intern}}: 1.5 U_r$	10	10 s	10 s

Continuation of "Technical data" see on next page!

SINEAX DME 424/442

Programmable Multi-Transducers

Analog outputs $\ominus \rightarrow$

For the outputs A, B, C and D:

Output variable Y	Impressed DC current	Impressed DC voltage
Full scale Y2	see "Ordering information"	see "Ordering information"
Limits of output signal for input overload and/or		
R = 0	$1.25 \cdot Y2$	40 mA
R $\rightarrow \infty$	30 V	$1.25 Y2$
Rated useful range of output load	$0 \leq \frac{7.5 \text{ V}}{Y2} \leq \frac{15 \text{ V}}{Y2}$	$\frac{Y2}{2 \text{ mA}} \leq \frac{Y2}{1 \text{ mA}} \leq \infty$
AC component of output signal (peak-to-peak)	$\leq 0.005 Y2$	$\leq 0.005 Y2$

The outputs A, B, C and D may be either short or open-circuited. They are electrically insulated from each other and from all other circuits (floating).

All the full-scale output values can be reduced subsequently using the programming software, but a supplementary error results.

The hardware full-scale settings for the analog outputs may also be changed subsequently. Conversion of a current to a voltage output or vice versa is also possible. This necessitates changing resistors on the output board. The full-scale values of the current and voltage outputs are set by varying the effective value of two parallel resistors (better resolution). The values of the resistors are selected to achieve the minimum absolute error. Calibration with the programming software is always necessary following conversion of the outputs. Refer to the Operating Instructions. **Caution: The warranty is void if the device is tampered with!**

Digital outputs, pulse outputs, limit outputs $\ominus \rightarrow$

The digital outputs conform to DIN 43 864. The pulse width can be neither programmed nor is there a hardware setting.

Type of contact:	Open collector
Number of pulse:	see "Ordering information"
Pulse duration:	$\geq 100 \text{ ms}$
Interval:	$\geq 100 \text{ ms}$
Power supply:	8 ... 40 V
Output current:	ON 10 ... 27 mA OFF $\leq 2 \text{ mA}$

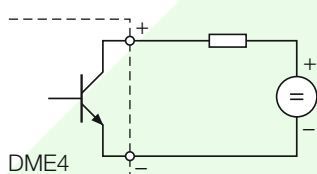

Reference conditions

Ambient temperature:	15 ... 30 °C
Pre-conditioning:	30 min. acc. to EN 60 688 Section 4.3, Table 2
Input variable:	Rated useful range
Power supply:	$H = H_n \pm 1\%$
Active/reactive factor:	$\cos \phi = 1$ resp. $\sin \phi = 1$
Frequency:	50 ... 60 Hz, 16 2/3 Hz
Waveform:	Sinusoidal, form factor 1.1107
Output load:	DC current output: $R_n = \frac{7.5 \text{ V}}{Y2} \pm 1\%$ DC voltage output: $R_n = \frac{Y2}{1 \text{ mA}} \pm 1\%$
Miscellaneous:	EN 60 688

System response

Accuracy class: (the reference value is the full-scale value Y2)

Measured variable	Condition	Accuracy class*
System: Active, reactive and apparent power	$0.5 \leq X2/Sr \leq 1.5$ $0.3 \leq X2/Sr < 0.5$	0.25 c 0.5 c
Phase: Active, reactive and apparent power	$0.167 \leq X2/Sr \leq 0.5$ $0.1 \leq X2/Sr < 0.167$	0.25 c 0.5 c
Power factor, active power factor and reactive power factor	$0.5Sr \leq S \leq 1.5 Sr$, $(X2 - X0) = 2$	0.25 c
	$0.5Sr \leq S \leq 1.5 Sr$, $1 \leq (X2 - X0) < 2$	0.5 c
	$0.5Sr \leq S \leq 1.5 Sr$, $0.5 \leq (X2 - X0) < 1$	1.0 c
	$0.1Sr \leq S < 0.5 Sr$, $(X2 - X0) = 2$	0.5 c
	$0.1Sr \leq S < 0.5 Sr$, $1 \leq (X2 - X0) < 2$	1.0 c
	$0.1Sr \leq S < 0.5 Sr$, $0.5 \leq (X2 - X0) < 1$	2.0 c
AC voltage	$0.1 Ur \leq U \leq 1.2 Ur$	0.2 c
AC current/ current averages	$0.1 Ir \leq I \leq 1.5 Ir$	0.2 c
System frequency	$0.1 Ur \leq U \leq 1.2 Ur$ resp. $0.1 Ir \leq I \leq 1.5 Ir$	$0.15 + 0.03 \text{ c}$ ($f_N = 50 \dots 60 \text{ Hz}$) $0.15 + 0,1 \text{ c}$ ($f_N = 16 \text{ 2/3 Hz}$)
Pulse Energy meter	acc. to IEC 1036 $0.1 Ir \leq I \leq 1.5 Ir$	1.0

* Basic accuracy 0.5 c for applications with phase-shift

SINEAX DME 424/442

Programmable Multi-Transducers

Duration of the measurement cycle: Approx. 0.25 to 0.5 s at 50 Hz, depending on measured variable and programming

Response time: 1 ... 2 times the measurement cycle

Factor c (the highest value applies):

Linear characteristic:	$c = \frac{1 - \frac{Y_0}{Y_2}}{1 - \frac{X_0}{X_2}} \text{ or } c = 1$
Bent characteristic:	
$X_0 \leq X \leq X_1$	$c = \frac{Y_1 - Y_0}{X_1 - X_0} \cdot \frac{X_2}{Y_2} \text{ or } c = 1$
$X_1 < X \leq X_2$	$c = \frac{1 - \frac{Y_1}{Y_2}}{1 - \frac{X_1}{X_2}} \text{ or } c = 1$

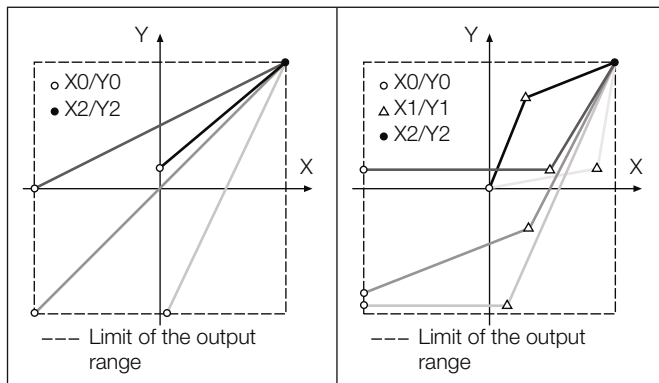

Fig. 3. Examples of settings with linear characteristic.

Fig. 4. Example of settings with bent characteristics.

Influencing quantities and permissible variations

Acc. to EN 60 688

Electrical safety

Protection class: II

Enclosure protection: IP40, housing
IP20, terminals

Installation category: III

Insulation test (versus earth):

Input voltage:	CA 400 V
Input current:	CA 400 V
Output:	CC 40 V
Power supply:	CA 400 V CC 230 V

Surge test: 5 kV; 1.2/50 μs; 0.5 Ws

Test voltages:

50 Hz, 1 min. acc. to EN 61 010-1

5550 V, inputs versus all other circuits as well as outer surface

3250 V, input circuits versus each other

3700 V, power supply versus outputs and SCI as well as outer surface

490 V, outputs and SCI versus each other and versus outer surface

Power supply →

AC/DC power pack (DC and 50 ... 60 Hz)

Table 1: Rated voltages and tolerances

Rated voltage U_N	Tolerance
24 ... 60 V CC/CA	CC - 15 ... + 33%
85 ... 230 V CC/CA	CA ± 10%

Consumption: ≤ 9 W resp. ≤ 10 VA

Programming connector on transducer

Interface: RS 232 C

DSUB socket: 9-pin

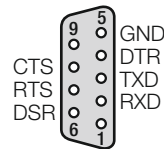

The interface is electrically insulated from all other circuits.

Installation data

Housing: Housing **T24**
See Section "Dimensioned drawings"

Housing material: Lexan 940 (polycarbonate).
flammability class V-0 acc. to UL 94,
self-extinguishing, non-dripping,
free of halogen

Mounting: For snapping onto top-hat rail
(35 x 15 mm or 35 x 7.5 mm) acc.
to EN 50 022
or
directly onto a wall or panel using
the pull-out screw hole brackets

Orientation: Any

Weight: With supply transformer
approx. 1.1 kg
With AC/DC power pack
approx. 0.7 kg

Terminals

Type: Screw terminals with wire guards

SINEAX DME 424/442

Programmable Multi-Transducers

Max. wire gauge: $\leq 4.0 \text{ mm}^2$ single wire or
2 x 2.5 mm² fine wire

Vibration withstand

(tested according to DIN EN 60 068-2-6)

Acceleration: $\pm 2 \text{ g}$
Frequency range: 10 ... 150 ... 10 Hz, rate of frequency sweep: 1 octave/minute
Number of cycles: 10 in each of the three axes
Result: No faults occurred, no loss of accuracy and no problems with the snap fastener

Ambient conditions

Variations due to ambient

temperature: $\pm 0.1\% / 10 \text{ K}$
Nominal range of use for temperature: 0...15...30...45 °C (usage group II)
Operating temperature: - 10 to + 55 °C
Storage temperature: - 40 to + 85 °C
Annual mean relative humidity: $\leq 75\%$
Altitude: 2000 m max.
Indoor use statement!

Table 2: Orderin information for SINEAX DME 424 with 2 analog and 4 digital outputs

DESCRIPTION	MARKING
1. Mechanical design Housing T24 for rail and wall mounting	424 - 1
2. Rated frequency 50 Hz (60 Hz possible without additional error; 16 2/3 Hz, additional error 1.25 · c) 60 Hz (50 Hz possible without additional error; 16 2/3 Hz, additional error 1.25 · c) 16 2/3 Hz (not re-programming by user, 50/60 Hz possible, but with additional error 1.25 · c)	1 2 3
3. Power supply DC/AC 24 ... 60 V, CSA approved DC/AC 85 ... 230 V, CSA approved	7 8
4. Power supply connection External (standard) External or internal from voltage input (not allowed for CSA) Not available for rated frequency 16 2/3 Hz and applications A15 / A16 / A24 (see Table 4) Caution: The power supply voltage must agree with the input voltage (Table 4)!	1 2
5. Full-scale output signal, output A Output A, Y2 = 20 mA (standard) Output A, Y2 (full-scale current Y2 [mA] 1 to 20) [mA] Output A, Y2 (full-scale voltage Y2 [V] 1 to 10) [V]	1 9 Z
6. Full-scale output signal, output B Output B, Y2 = 20 mA (standard) Output B, Y2 (full-scale current Y2 [mA] 1 to 20) [mA] Output B, Y2 (full-scale voltage Y2 [V] 1 to 10) [V]	1 9 Z
7. Test certificate None supplied Supplied	0 1
8. Programming Basic (not available if the power supply is taken from the voltage input) According to specification All the programming data must be entered on Form W 2386e (see appendix 1) and the form must be included with the order!	0 9

SINEAX DME 424/442

Programmable Multi-Transducers

Table 3: Ordering information for SINEAX DME 442 with 4 analog and 2 digital outputs

DESCRIPTION	MARKING
1. Mechanical design Housing T24 for rail and wall mounting	442 – 1
2. Rated frequency 50 Hz (60 Hz possible without additional error; 16 2/3 Hz, additional error 1.25 · c)	1
60 Hz (50 Hz possible without additional error; 16 2/3 Hz, additional error 1.25 · c)	2
16 2/3 Hz (not re-programming by user, 50/60 Hz possible, but with additional error 1.25 · c)	3
3. Power supply DC/AC 24 ... 60 V, CSA approved	7
DC/AC 85 ... 230 V, CSA approved	8
4. Power supply connection External (standard)	1
Internal from voltage input (not allowed for CSA) (not available for rated frequency 16 2/3 Hz and applications A15 / A16 / A24 (see Table 4))	2
Caution: The power supply voltage must agree with the input voltage (Table 4)!	
5. Full-scale output signal, output A Output A, Y2 = 20 mA (standard)	1
Output A, Y2 (full-scale current Y2 [mA] 1 to 20)	9
Output A, Y2 (full-scale voltage Y2 [V] 1 to 10)	Z
6. Full-scale output signal, output B Output B, Y2 = 20 mA (standard)	1
Output B, Y2 (full-scale current Y2 [mA] 1 to 20)	9
Output B, Y2 (full-scale voltage Y2 [V] 1 to 10)	Z
7. Full-scale output signal, output C Output C, Y2 = 20 mA (standard)	1
Output C, Y2 (full-scale current Y2 [mA] 1 to 20)	9
Output C, Y2 (full-scale voltage Y2 [V] 1 to 10)	Z
8. Full-scale output signal, output D Output D, Y2 = 20 mA (standard)	1
Output D, Y2 (full-scale current Y2 [mA] 1 to 20)	9
Output D, Y2 (full-scale voltage Y2 [V] 1 to 10)	Z
9. Test certificate None supplied	0
Supplied	1
10. Programming Basic (not available if the power supply is taken from the voltage input)	0
According to specification	9
All the programming data must be entered on W 2387e (see appendix 2) and the form must be included with the order !	

SINEAX DME 424/442

Programmable Multi-Transducers

Table 4: Programming for types DME 424 and 442

DESCRIPTION	Application		
	A11... A16	A34	A24/A44
1. Application (system)			
Single-phase AC	A11	—	—
3-wire, 3-phase symmetric load, phase-shift U: L1-L2, I: L1*	A12	—	—
3-wire, 3-phase symmetric load	A13	—	—
4-wire, 3-phase symmetric load	A14	—	—
3-wire, 3-phase symmetric load, phase-shift U: L3-L1, I: L1*	A15	—	—
3-wire, 3-phase symmetric load, phase-shift U: L2-L3, I: L1*	A16	—	—
3-wire, 3-phase asymmetric load	—	A34	—
4-wire, 3-phase asymmetric load	—	—	A44
4-wire, 3-phase asymmetric load, open Y	—	—	A24
2. Input voltage			
Rated value $U_r = 57.7 \text{ V}$	U01	—	—
Rated value $U_r = 63.5 \text{ V}$	U02	—	—
Rated value $U_r = 100 \text{ V}$	U03	—	—
Rated value $U_r = 110 \text{ V}$	U04	—	—
Rated value $U_r = 120 \text{ V}$	U05	—	—
Rated value $U_r = 230 \text{ V}$	U06	—	—
Rated value U_r ($U_r [\text{V}] 57$ to 400) [M]	U91	—	—
Rated value $U_r = 100 \text{ V}$	U21	U21	U21
Rated value $U_r = 110 \text{ V}$	U22	U22	U22
Rated value $U_r = 115 \text{ V}$	U23	U23	U23
Rated value $U_r = 120 \text{ V}$	U24	U24	U24
Rated value $U_r = 400 \text{ V}$	U25	U25	U25
Rated value $U_r = 500 \text{ V}$	U26	U26	U26
Rated value U_r ($U_r [\text{V}] > 100$ to 693) [M]	U93	U93	U93
Lines U01 to U06: Only for single phase AC current or 4-wire, 3-phase symmetric load			
3. Input current			
Rated value $I_r = 1 \text{ A}$	V1	V1	V1
Rated value $I_r = 2 \text{ A}$	V2	V2	V2
Rated value $I_r = 5 \text{ A}$	V3	V3	V3
Rated value I_r ($I_r [\text{A}] > 1$ to 6) [A]	V9	V9	V9
4. Primary rating (primary transformer)			
Without specification of primary rating	W0	W0	W0
CT = _____ A / _____ A VT = _____ kV / _____ V	W9	W9	W9
Specify transformer ratio prim./sec. 1000/5 A; 33 kV/110 V			
5. Measured variable, output A			
Not used	AA000	AA000	AA000
Initial value X0 Final value X2			
U System $X_0 = 0$ $X_2 = U_r^*$	AA001	—	—
U12 L1-L2 $X_0 = 0$ $X_2 = U_r^*$	—	AA001	AA001
U System $0 \leq X_0 \leq 0.9 \cdot X_2$ $0.8 \cdot U_r \leq X_2 \leq 1.2 \cdot U_r^*$	AA901	—	—
U1N L1-N $0 \leq X_0 \leq 0.9 \cdot X_2$ $0.8 \cdot U_r / \sqrt{3} \leq X_2 \leq 1.2 \cdot U_r / \sqrt{3}^*$	—	—	AA902

SINEAX DME 424/442

Programmable Multi-Transducers

DESCRIPTION				Application		
				A11... A16	A34	A24/A44
5. Measured variable, output A (continuation)						
		Initial value X0	Final value X2			
U2N	L2-N	$0 \leq X0 \leq 0.9 \cdot X2$	$0.8 \cdot Ur / \sqrt{3} \leq X2 \leq 1.2 \cdot Ur / \sqrt{3}^*$	—	—	AA903
U3N	L3-N	$0 \leq X0 \leq 0.9 \cdot X2$	$0.8 \cdot Ur / \sqrt{3} \leq X2 \leq 1.2 \cdot Ur / \sqrt{3}^*$	—	—	AA904
U12	L1-L2	$0 \leq X0 \leq 0.9 \cdot X2$	$0.8 \cdot Ur \leq X2 \leq 1.2 \cdot Ur^*$	—	AA905	AA905
U23	L2-L3	$0 \leq X0 \leq 0.9 \cdot X2$	$0.8 \cdot Ur \leq X2 \leq 1.2 \cdot Ur^*$	—	AA906	AA906
U31	L3-L1	$0 \leq X0 \leq 0.9 \cdot X2$	$0.8 \cdot Ur \leq X2 \leq 1.2 \cdot Ur^*$	—	AA907	AA907
I	System	$0 \leq X0 \leq 0.8 \cdot X2$	$0.5 \cdot Ir \leq X2 \leq 1.5 \cdot Ir$	AA908	—	—
I1	L1	$0 \leq X0 \leq 0.8 \cdot X2$	$0.5 \cdot Ir \leq X2 \leq 1.5 \cdot Ir$	—	AA909	AA909
I2	L2	$0 \leq X0 \leq 0.8 \cdot X2$	$0.5 \cdot Ir \leq X2 \leq 1.5 \cdot Ir$	—	AA910	AA910
I3	L3	$0 \leq X0 \leq 0.8 \cdot X2$	$0.5 \cdot Ir \leq X2 \leq 1.5 \cdot Ir$	—	AA911	AA911
P	System	$-X2 \leq X0 \leq 0.8 \cdot X2$	$0.3 \cdot X2 / Sr \leq 1.5$	AA912	AA912	AA912
P1	L1	$-X2 \leq X0 \leq 0.8 \cdot X2$	$0.1 \cdot X2 / Sr \leq 0.5$	—	—	AA913
P2	L2	$-X2 \leq X0 \leq 0.8 \cdot X2$	$0.1 \cdot X2 / Sr \leq 0.5$	—	—	AA914
P3	L3	$-X2 \leq X0 \leq 0.8 \cdot X2$	$0.1 \cdot X2 / Sr \leq 0.5$	—	—	AA915
Q	System	$-X2 \leq X0 \leq 0.8 \cdot X2$	$0.3 \cdot X2 / Sr \leq 1.5$	AA916	AA916	AA916
Q1	L1	$-X2 \leq X0 \leq 0.8 \cdot X2$	$0.1 \cdot X2 / Sr \leq 0.5$	—	—	AA917
Q1	L2	$-X2 \leq X0 \leq 0.8 \cdot X2$	$0.1 \cdot X2 / Sr \leq 0.5$	—	—	AA918
Q3	L3	$-X2 \leq X0 \leq 0.8 \cdot X2$	$0.1 \cdot X2 / Sr \leq 0.5$	—	—	AA919
PF	System	$-1 \leq X0 \leq (X2 - 0.5)$	$0 \leq X2 \leq 1$	AA920	AA920	AA920
PF1	L1	$-1 \leq X0 \leq (X2 - 0.5)$	$0 \leq X2 \leq 1$	—	—	AA921
PF2	L2	$-1 \leq X0 \leq (X2 - 0.5)$	$0 \leq X2 \leq 1$	—	—	AA922
PF3	L3	$-1 \leq X0 \leq (X2 - 0.5)$	$0 \leq X2 \leq 1$	—	—	AA923
QF	System	$-1 \leq X0 \leq (X2 - 0.5)$	$0 \leq X2 \leq 1$	AA924	AA924	AA924
QF1	L1	$-1 \leq X0 \leq (X2 - 0.5)$	$0 \leq X2 \leq 1$	—	—	AA925
QF2	L2	$-1 \leq X0 \leq (X2 - 0.5)$	$0 \leq X2 \leq 1$	—	—	AA926
QF3	L3	$-1 \leq X0 \leq (X2 - 0.5)$	$0 \leq X2 \leq 1$	—	—	AA927
F		$15.3 \text{ Hz} \leq X0 \leq X2 - 1 \text{ Hz}$	$X0 + 1 \text{ Hz} \leq X2 \leq 65 \text{ Hz}$	AA928	AA928	AA928
S	System	$0 \leq X0 \leq 0.8 \cdot X2$	$0.3 \leq X2 / Sr \leq 1.5$	AA929	AA929	AA929
S1	L1	$0 \leq X0 \leq 0.8 \cdot X2$	$0.1 \leq X2 / Sr \leq 0.5$	—	—	AA930
S2	L2	$0 \leq X0 \leq 0.8 \cdot X2$	$0.1 \leq X2 / Sr \leq 0.5$	—	—	AA931
S3	L3	$0 \leq X0 \leq 0.8 \cdot X2$	$0.1 \leq X2 / Sr \leq 0.5$	—	—	AA932
IM	System	$0 \leq X0 \leq 0.8 \cdot X2$	$0.5 \cdot Ir \leq X2 \leq 1.5 \cdot Ir$	—	AA933	AA933
IMS	System	$-X2 \leq X0 \leq 0.8 \cdot X2$	$0.5 \cdot Ir \leq X2 \leq 1.5 \cdot Ir$	—	AA934	AA934
LF	System	$-1 \leq X0 \leq (X2 - 0.5)$	$0 \leq X2 \leq 1$	AA935	AA935	AA935
LF1	L1	$-1 \leq X0 \leq (X2 - 0.5)$	$0 \leq X2 \leq 1$	—	—	AA936
LF2	L2	$-1 \leq X0 \leq (X2 - 0.5)$	$0 \leq X2 \leq 1$	—	—	AA937
LF3	L3	$-1 \leq X0 \leq (X2 - 0.5)$	$0 \leq X2 \leq 1$	—	—	AA938
IB	System	$X0 = 0$ $1 \leq IBT \leq 30 \text{ min}$	$0.5 \cdot Ir \leq X2 \leq 1.5 \cdot Ir$	AA939	—	—
IB1	L1	$X0 = 0$ $1 \leq IBT \leq 30 \text{ min}$	$0.5 \cdot Ir \leq X2 \leq 1.5 \cdot Ir$	—	AA940	AA940
IB2	L2	$X0 = 0$ $1 \leq IBT \leq 30 \text{ min}$	$0.5 \cdot Ir \leq X2 \leq 1.5 \cdot Ir$	—	AA941	AA941
IB3	L3	$X0 = 0$ $1 \leq IBT \leq 30 \text{ min}$	$0.5 \cdot Ir \leq X2 \leq 1.5 \cdot Ir$	—	AA942	AA942
BS	System	$X0 = 0$ $1 \leq BST \leq 30 \text{ min}$	$0.5 \cdot Ir \leq X2 \leq 1.5 \cdot Ir$	AA943	—	—
BS1	L1	$X0 = 0$ $1 \leq BST \leq 30 \text{ min}$	$0.5 \cdot Ir \leq X2 \leq 1.5 \cdot Ir$	—	AA944	AA944
BS2	L2	$X0 = 0$ $1 \leq BST \leq 30 \text{ min}$	$0.5 \cdot Ir \leq X2 \leq 1.5 \cdot Ir$	—	AA945	AA945
BS3	L3	$X0 = 0$ $1 \leq BST \leq 30 \text{ min}$	$0.5 \cdot Ir \leq X2 \leq 1.5 \cdot Ir$	—	AA946	AA946
UM	System	$0 \leq X0 \leq 0.8 \cdot X2$	$0.8 \cdot Ur / \sqrt{3} \leq X2 \leq 1.2 \cdot Ur / \sqrt{3}^*$	—	—	AA947

* Where the power supply is taken from the measured voltage, the transmitter only operates in the range $U = 0.8 Ur \dots 1.2 Ur$ and the specified accuracy is only guaranteed in the range $U = 0.9 Ur \dots 1.1 Ur$.

SINEAX DME 424/442

Programmable Multi-Transducers

DESCRIPTION	Application		
	A11... A16	A34	A24/A44
6. Output signal, output A			
Initial value Y0			
Final value Y2			
DC current Y0 = 0	AB01	AB01	AB01
– Y2 ≤ Y0 ≤ 0.2 · Y2	AB91	AB91	AB91
DC voltage – Y2 ≤ Y0 ≤ 0.2 · Y2	AB92	AB92	AB92
7. Characteristic, output A			
Linear	AC01	AC01	AC01
Bent (X0 + 0.015 · X2) ≤ X1 ≤ 0.985 · X2 Y0 ≤ Y1 ≤ Y2	AC91	AC91	AC91
8. Limits, output A			
Standard Ymin = Y0 – 0.25 Y2 Ymax = 1.25 Y2	AD01	AD01	AD01
(Y0 – 0.25 Y2) ≤ Ymin ≤ Y0 Y2 ≤ Ymax ≤ 1.25 Y2	AD91	AD91	AD91
9. Measured variable, output B			
Same as output A, but markings start with a capital B	BA ...	BA ...	BA ...
10. Output signal, output B			
Same as output A, but markings start with a capital B	BB ..	BB ..	BB ..
11. Characteristic, output B			
Same as output A, but markings start with a capital B	BC ..	BC ..	BC ..
12. Limits, output B			
Same as output A, but markings start with a capital B	BD ..	BD ..	BD ..
Only for type DME 442			
13. Measured variable, output C			
Same as output A, but markings start with a capital C	CA ...	CA ...	CA ...
14. Output signal, output C			
Same as output A, but markings start with a capital C	CB ..	CB ..	CB ..
15. Characteristic, output C			
Same as output A, but markings start with a capital C	CC ..	CC ..	CC ..
16. Limits, output C			
Same as output A, but markings start with a capital C	CD ..	CD ..	CD ..
17. Measured variable, output D			
Same as output A, but markings start with a capital D	DA ..	DA ..	DA ..
18. Output signal, output D			
Same as output A, but markings start with a capital D	DB ..	DB ..	DB ..
19. Characteristic, output D			
Same as output A, but markings start with a capital D	DC ..	DC ..	DC ..
20. Limits, output D			
Same as output A, but markings start with a capital D	DD ..	DD ..	DD ..

SINEAX DME 424/442

Programmable Multi-Transducers

DESCRIPTION				Application		
				A11... A16	A34	A24/A44
Only for type DME 424						
21. Measured variable, output E						
Not used				EA000	EA000	EA000
Pulse	X0 = 0	Y0 = 0				
I	System	$0.1 \leq X_i \leq (4800 \cdot 1 \text{ A} / I_r)$	[Imp/Ah]	EA950	—	—
I1	L1	$0.1 \leq X_i \leq (4800 \cdot 1 \text{ A} / I_r)$	[Imp/Ah]	—	EA951	EA951
I2	L2	$0.1 \leq X_i \leq (4800 \cdot 1 \text{ A} / I_r)$	[Imp/Ah]	—	EA952	EA952
I3	L3	$0.1 \leq X_i \leq (4800 \cdot 1 \text{ A} / I_r)$	[Imp/Ah]	—	EA953	EA953
S	System	$0.1 \leq X_i \leq (4000 \cdot 1 \text{ kVA} / S_r)$	[Imp/kVAh]	EA954	EA954	EA954
S1	L1	$0.3 \leq X_i \leq (12000 \cdot 1 \text{ kVA} / S_r)$	[Imp/kVAh]	—	—	EA955
S2	L2	$0.3 \leq X_i \leq (12000 \cdot 1 \text{ kVA} / S_r)$	[Imp/kVAh]	—	—	EA956
S3	L3	$0.3 \leq X_i \leq (12000 \cdot 1 \text{ kVA} / S_r)$	[Imp/kVAh]	—	—	EA957
P	System (incoming)	$0.1 \leq X_i \leq (4000 \cdot 1 \text{ kVA} / S_r)$	[Imp/kWh]	EA958	EA958	EA958
P1	L1 (incoming)	$0.3 \leq X_i \leq (12000 \cdot 1 \text{ kVA} / S_r)$	[Imp/kWh]	—	—	EA959
P2	L2 (incoming)	$0.3 \leq X_i \leq (12000 \cdot 1 \text{ kVA} / S_r)$	[Imp/kWh]	—	—	EA960
P3	L3 (incoming)	$0.3 \leq X_i \leq (12000 \cdot 1 \text{ kVA} / S_r)$	[Imp/kWh]	—	—	EA961
Q	System (inductive)	$0.1 \leq X_i \leq (4000 \cdot 1 \text{ kVA} / S_r)$	[Imp/kvarh]	EA962	EA962	EA962
Q1	L1 (inductive)	$0.3 \leq X_i \leq (12000 \cdot 1 \text{ kVA} / S_r)$	[Imp/kvarh]	—	—	EA963
Q2	L2 (inductive)	$0.3 \leq X_i \leq (12000 \cdot 1 \text{ kVA} / S_r)$	[Imp/kvarh]	—	—	EA964
Q3	L3 (inductive)	$0.3 \leq X_i \leq (12000 \cdot 1 \text{ kVA} / S_r)$	[Imp/kvarh]	—	—	EA965
P	System (outgoing)	$0.1 \leq X_i \leq (4000 \cdot 1 \text{ kVA} / S_r)$	[Imp/kWh]	EA966	EA966	EA966
P1	L1 (outgoing)	$0.3 \leq X_i \leq (12000 \cdot 1 \text{ kVA} / S_r)$	[Imp/kWh]	—	—	EA967
P2	L2 (outgoing)	$0.3 \leq X_i \leq (12000 \cdot 1 \text{ kVA} / S_r)$	[Imp/kWh]	—	—	EA968
P3	L3 (outgoing)	$0.3 \leq X_i \leq (12000 \cdot 1 \text{ kVA} / S_r)$	[Imp/kWh]	—	—	EA969
Q	System (capacitive)	$0.1 \leq X_i \leq (4000 \cdot 1 \text{ kVA} / S_r)$	[Imp/kvarh]	EA970	EA970	EA970
Q1	L1 (capacitive)	$0.3 \leq X_i \leq (12000 \cdot 1 \text{ kVA} / S_r)$	[Imp/kvarh]	—	—	EA971
Q2	L2 (capacitive)	$0.3 \leq X_i \leq (12000 \cdot 1 \text{ kVA} / S_r)$	[Imp/kvarh]	—	—	EA972
Q3	L3 (capacitive)	$0.3 \leq X_i \leq (12000 \cdot 1 \text{ kVA} / S_r)$	[Imp/kvarh]	—	—	EA973
Limit contact I						
Limit value XI						
U	System	$0 \leq X_i \leq 1.2 \cdot U_r$		EA901	—	—
U1N	L1-N	$0 \leq X_i \leq 1.2 \cdot U_r / \sqrt{3}$		—	—	EA902
U2N	L2-N	$0 \leq X_i \leq 1.2 \cdot U_r / \sqrt{3}$		—	—	EA903
U3N	L3-N	$0 \leq X_i \leq 1.2 \cdot U_r / \sqrt{3}$		—	—	EA904
U12	L1-L2	$0 \leq X_i \leq 1.2 \cdot U_r$		—	EA905	EA905
U23	L2-L3	$0 \leq X_i \leq 1.2 \cdot U_r$		—	EA906	EA906
U31	L3-L1	$0 \leq X_i \leq 1.2 \cdot U_r$		—	EA907	EA907
I	System	$0 \leq X_i \leq 1.5 \cdot I_r$		EA908	—	—
I1	L1	$0 \leq X_i \leq 1.5 \cdot I_r$		—	EA909	EA909
I2	L2	$0 \leq X_i \leq 1.5 \cdot I_r$		—	EA910	EA910
I3	L3	$0 \leq X_i \leq 1.5 \cdot I_r$		—	EA911	EA911
P	System	$-1.5 \leq X_i / S_r \leq 1.5$		EA912	EA912	EA912
P1	L1	$-0.5 \leq X_i / S_r \leq 0.5$		—	—	EA913
P2	L2	$-0.5 \leq X_i / S_r \leq 0.5$		—	—	EA914
P3	L3	$-0.5 \leq X_i / S_r \leq 0.5$		—	—	EA915
Q	System	$-1.5 \leq X_i / S_r \leq 1.5$		EA916	EA916	EA916
Q1	L1	$-0.5 \leq X_i / S_r \leq 0.5$		—	—	EA917
Q2	L2	$-0.5 \leq X_i / S_r \leq 0.5$		—	—	EA918
Q3	L3	$-0.5 \leq X_i / S_r \leq 0.5$		—	—	EA919

SINEAX DME 424/442

Programmable Multi-Transducers

DESCRIPTION	Application		
	A11... A16	A34	A24/A44
Limit contact I (continuation)			
Limit value XI			
PF System $-1 \leq XI \leq 1$	EA920	EA920	EA920
PF1 L1 $-1 \leq XI \leq 1$	—	—	EA921
PF2 L2 $-1 \leq XI \leq 1$	—	—	EA922
PF3 L3 $-1 \leq XI \leq 1$	—	—	EA923
QF System $-1 \leq XI \leq 1$	EA924	EA924	EA924
QF1 L1 $-1 \leq XI \leq 1$	—	—	EA925
QF2 L2 $-1 \leq XI \leq 1$	—	—	EA926
QF3 L3 $-1 \leq XI \leq 1$	—	—	EA927
F $15.3 \text{ Hz} \leq XI \leq 65 \text{ Hz}$	EA928	EA928	EA928
S System $0 \leq XI / Sr \leq 1.5$	EA929	EA929	EA929
S1 L1 $0 \leq XI / Sr \leq 0.5$	—	—	EA930
S2 L2 $0 \leq XI / Sr \leq 0.5$	—	—	EA931
S3 L2 $0 \leq XI / Sr \leq 0.5$	—	—	EA932
IM System $0 \leq XI / Ir \leq 1.5$	—	EA933	EA933
IMS System $-1.5 \leq XI / Ir \leq 1.5$	—	EA934	EA934
LF System $-1 \leq XI \leq 1$	EA935	EA935	EA935
LF1 L1 $-1 \leq XI \leq 1$	—	—	EA936
LF2 L2 $-1 \leq XI \leq 1$	—	—	EA937
LF3 L3 $-1 \leq XI \leq 1$	—	—	EA938
IB System $1 \leq IBT \leq 30 \text{ min}$	$0 \leq XI / Ir \leq 1.5$	EA939	—
IB1 L1 $1 \leq IBT \leq 30 \text{ min}$	$0 \leq XI / Ir \leq 1.5$	—	EA940
IB2 L2 $1 \leq IBT \leq 30 \text{ min}$	$0 \leq XI / Ir \leq 1.5$	—	EA941
IB3 L3 $1 \leq IBT \leq 30 \text{ min}$	$0 \leq XI / Ir \leq 1.5$	—	EA942
BS System $1 \leq BST \leq 30 \text{ min}$	$0 \leq XI / Ir \leq 1.5$	EA943	—
BS1 L1 $1 \leq BST \leq 30 \text{ min}$	$0 \leq XI / Ir \leq 1.5$	—	EA944
BS2 L2 $1 \leq BST \leq 30 \text{ min}$	$0 \leq XI / Ir \leq 1.5$	—	EA945
BS3 L3 $1 \leq BST \leq 30 \text{ min}$	$0 \leq XI / Ir \leq 1.5$	—	EA946
UM System $0 \leq X1 \leq 1.2 \cdot Ur$	—	—	EA947
22. Output signal, output E (only for EA901 ... EA947)			
ON if $X1 > X1$	OFF if $X1 < X1$	EB01	EB01
$X1 < X1$	$X1 > X1$	EB02	EB02
23. Pick-up delay, output E (only for EA901 ... EA947)			
Minimum	EC01	EC01	EC01
$1 \leq Y \text{ Del} \leq 30 \text{ s}$	EC91	EC91	EC91
Only for type DME 424			
24. Measured variable, output F			
Same as output E, but markings start with a capital F	FA ..	FA ..	FA ..
25. Output signal, output F			
Same as output E, but markings start with a capital F	FB ..	FB ..	FB ..
26. Pick-up delay, output F			
Same as output E, but markings start with a capital F	FC ..	FC ..	FC ..
For types DME 424 and 442			
27. Measured variable, output G			
Same as output E, but markings start with a capital G	GA ..	GA ..	GA ..
28. Output signal, output G			
Same as output E, but markings start with a capital G	GB ..	GB ..	GB ..

SINEAX DME 424/442

Programmable Multi-Transducers

DESCRIPTION	Application		
	A11... A16	A34	A24/A44
29. Pick-up delay, output G Same as output E, but markings start with a capital G	GC ..	GC ..	GC ..
For types DME 424 and 442 30. Measured variable, output H Same as output E, but markings start with a capital H	HA ..	HA ..	HA ..
31. Output signal, output H Same as output E, but markings start with a capital H	HB ..	HB ..	HB ..
32. Pick-up delay, output H Same as output E, but markings start with a capital H	HC ..	HC ..	HC ..

Note: Up to three limite can be assigned to digital outputs G and H using the programming software.

Electrical connections

Function	Connection			
Measuring input $\rightarrow \bigcirc$ AC current	IL1	1 / 3		
	IL2	4 / 6		
	IL3	7 / 9		
	AC voltage	UL1	2	
		UL2	5	
		UL3	8	
	N	11		
Outputs \rightarrow Analog Digital	\rightarrow A	+	15	
		-	16	
	\rightarrow B	+	17	
		-	18	
	\rightarrow C	\rightarrow E	+	19
		-	20	
	\rightarrow D	\rightarrow F	+	21
		-	22	
		\rightarrow G	+	23
		-	24	
		\rightarrow H	+	25
		-	26	
Power supply $\rightarrow \bigcirc$ AC	~	13		
	~	14		
	DC	+	13	
		-	14	

If power supply is taken from the measured voltage internal connections are as follow:

Application (system)	Internal connection Terminal / System
Single phase AC current	2 / 11 (L1 - N)
4-wire 3-phase symmetric load	2 / 11 (L1 - N)
All other (apart from A15 / A16 / A24)	2 / 5 (L1 - L2)

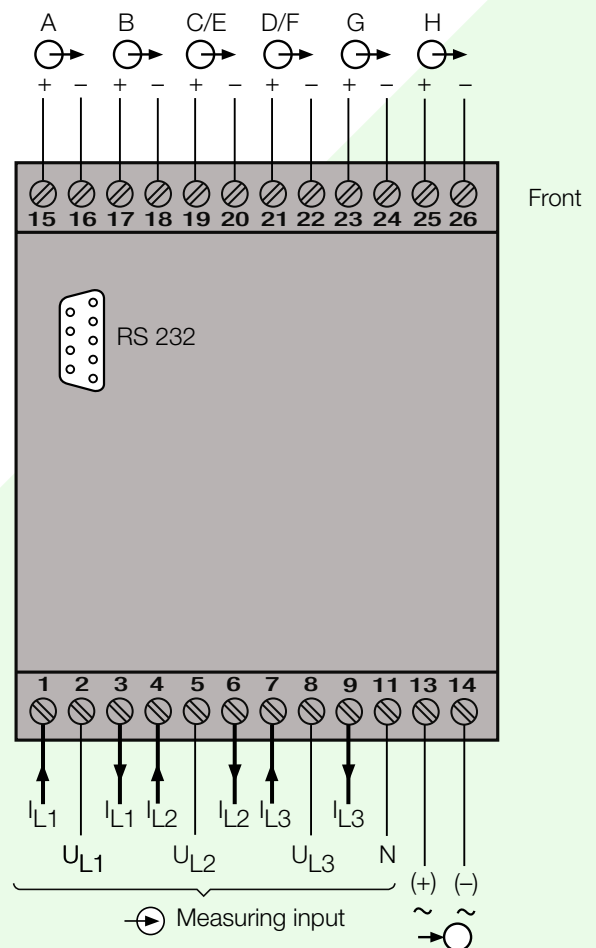

SINEAX DME 424/442

Programmable Multi-Transducers

Measuring input

System/
application

Terminals

Single-phase
AC system

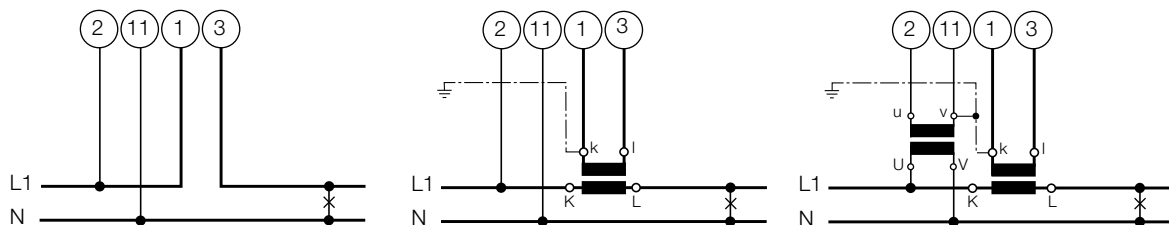

3-wire
3-phase
symmetric
load
I: L1

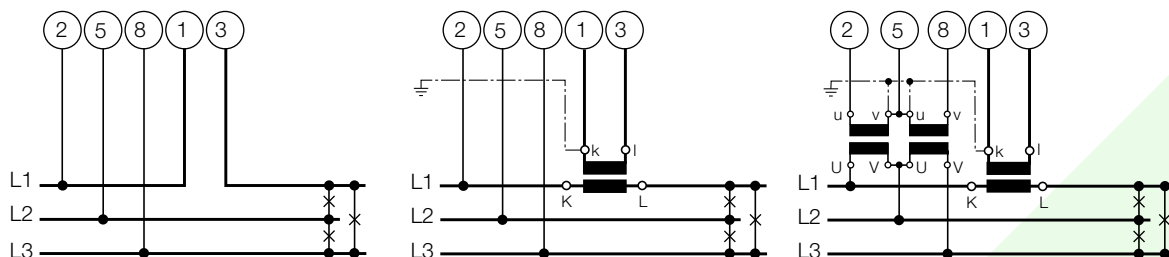

Connect the voltage according to the following table for current measurement in L2 or L3:

Current transformer	Terminals	2	5	8
L2	1 3	L2	L3	L1
L3	1 3	L3	L1	L2

3-wire
3-phase
symmetric
load
Phase-shift
U: L1 - L2
I: L1

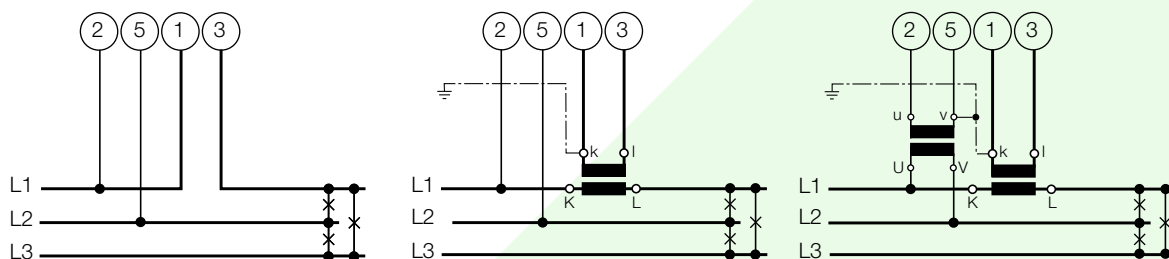

Connect the voltage according to the following table for current measurement in L2 or L3:

Current transformer	Terminals	2	5
L2	1 3	L2	L3
L3	1 3	L3	L1

3-wire
3-phase
symmetric
load
Phase-shift
U: L3 - L1
I: L1

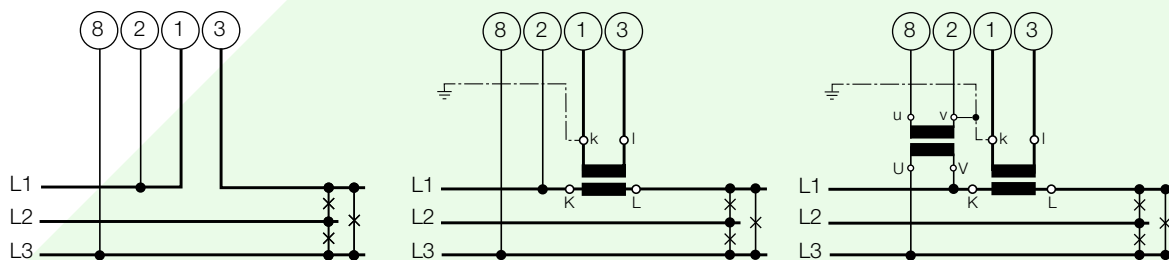

Connect the voltage according to the following table for current measurement in L2 or L3:

Current transformer	Terminals	8	2
L2	1 3	L1	L2
L3	1 3	L2	L3

SINEAX DME 424/442

Programmable Multi-Transducers

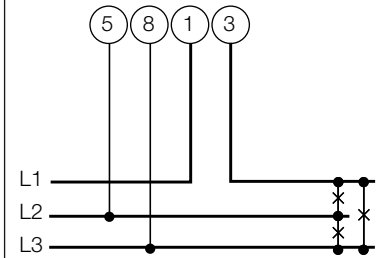
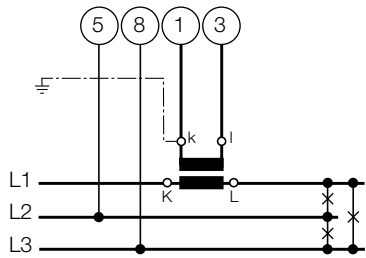
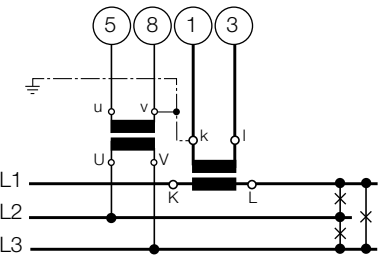
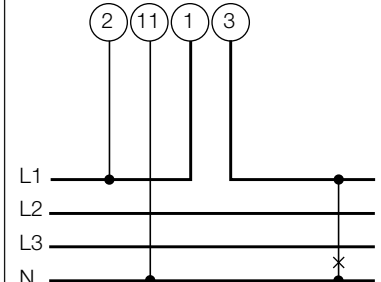
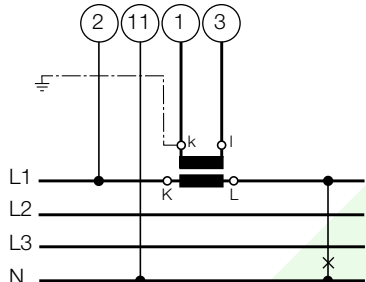
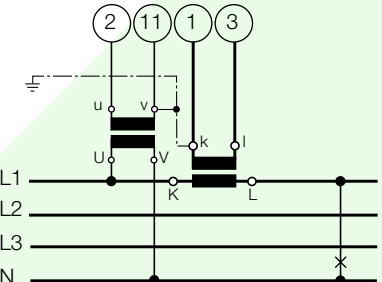
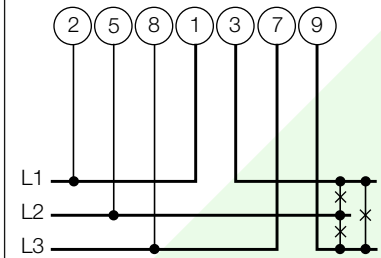
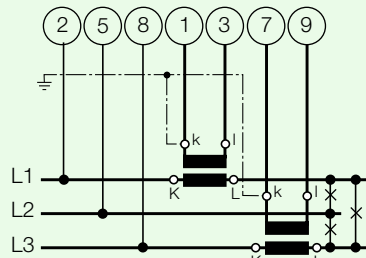
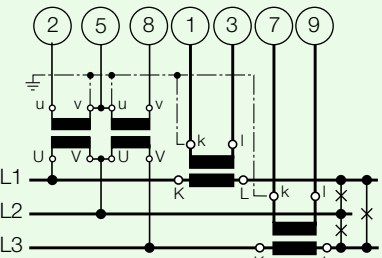
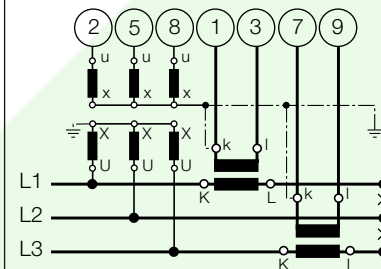
Measuring input																
System / application	Terminals															
<p>3-wire 3-phase symmetric load Phase-shift U: L2 – L3 I: L1</p>	<div style="display: flex; justify-content: space-around;">    </div> <p>Connect the voltage according to the following table for current measurement in L2 or L3:</p> <table border="1" style="width: 100%; border-collapse: collapse; margin-top: 10px;"> <thead> <tr> <th>Current transformer</th> <th colspan="2">Terminals</th> <th>5</th> <th>8</th> </tr> </thead> <tbody> <tr> <td>L2</td> <td>1</td> <td>3</td> <td>L3</td> <td>L1</td> </tr> <tr> <td>L3</td> <td>1</td> <td>3</td> <td>L1</td> <td>L2</td> </tr> </tbody> </table>	Current transformer	Terminals		5	8	L2	1	3	L3	L1	L3	1	3	L1	L2
Current transformer	Terminals		5	8												
L2	1	3	L3	L1												
L3	1	3	L1	L2												
<p>4-wire 3-phase symmetric load I: L1</p>	<div style="display: flex; justify-content: space-around;">    </div> <p>Connect the voltage according to the following table for current measurement in L2 or L3:</p> <table border="1" style="width: 100%; border-collapse: collapse; margin-top: 10px;"> <thead> <tr> <th>Current transformer</th> <th colspan="2">Terminals</th> <th>2</th> <th>11</th> </tr> </thead> <tbody> <tr> <td>L2</td> <td>1</td> <td>3</td> <td>L2</td> <td>N</td> </tr> <tr> <td>L3</td> <td>1</td> <td>3</td> <td>L3</td> <td>N</td> </tr> </tbody> </table>	Current transformer	Terminals		2	11	L2	1	3	L2	N	L3	1	3	L3	N
Current transformer	Terminals		2	11												
L2	1	3	L2	N												
L3	1	3	L3	N												
<p>3-wire 3-phase asymmetric load</p>	<div style="display: flex; flex-direction: column; align-items: center;">    </div> <div style="margin-top: 20px;">  </div>															

SINEAX DME 424/442

Programmable Multi-Transducers

Measuring inputs	
System / application	Terminals
4-wire 3-phase asymmetric load	
	<p>3 single-pole insulated voltage transformers in high-voltage system</p>
4-wire 3-phase asymmetric load, Open Y connection	<p>Low-voltage system</p>
	<p>2 single-pole insulated voltage transformers in high-voltage system</p>

Relationship between PF, QF and LF

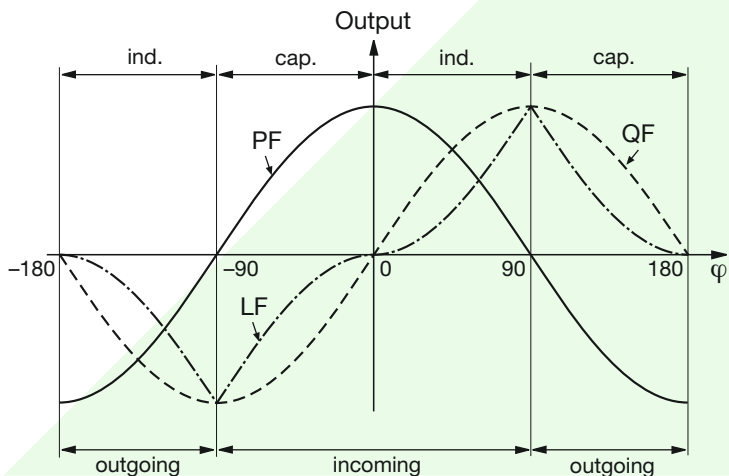

Fig. 5. Active power PF —, reactive power QF -----, power factor LF - - - - -.

SINEAX DME 424/442 Programmable Multi-Transducers

Dimensional drawings

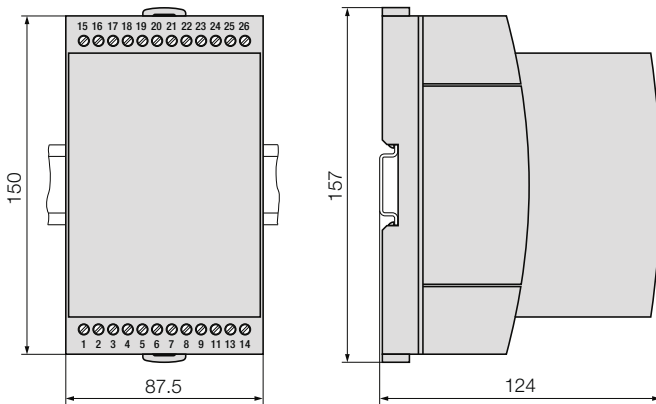

Fig. 6. SINEAX DME 424/442 in housing **T24** clipped onto a top-hat rail (35 x 15 mm or 35 x 7.5 mm, acc. to EN 50 022).

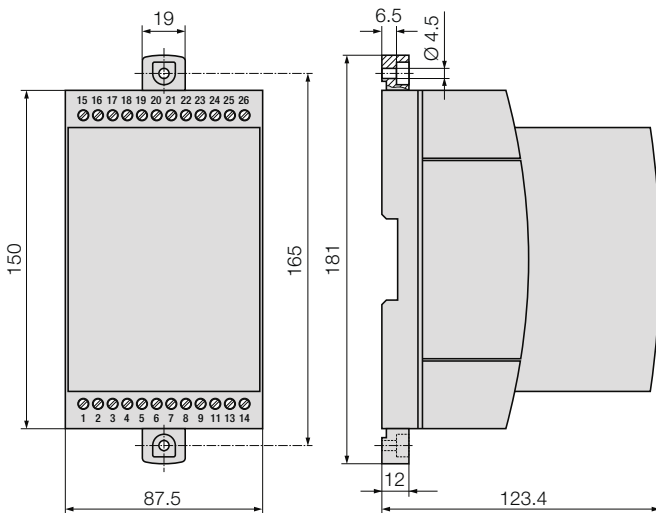
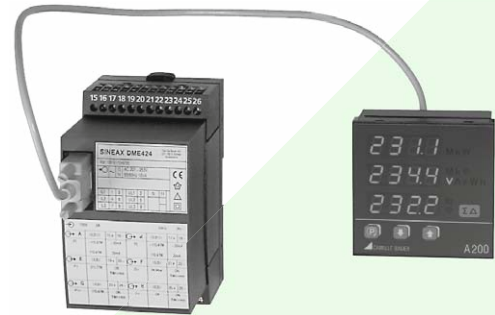

Fig. 6. SINEAX DME 424/442 in housing **T24**, screw hole mounting brackets pulled out.

Table 5: Accessories

Description	Order No.
Programming cable	980 179
Configuration software DME 4 for SINEAX/EURAX DME 424, 440, 442, SINEAX DME 400, 401 and 406 Windows 3.1x, 95, 98, NT and 2000 on CD in German, English, French, Italian and Dutch (Download free of charge under www.camillebauer.com) In addition, the CD contains all configuration programmes presently available for Camille Bauer products.	146 557
Operating Instructions DME 424/442-1 B d-f-e	122 250



Description	Order No.
SINEAX A 200	154 063
Interconnecting cable sub D 9 pol. male/male 1.8 m	154 071

Standard accessories

- 1 Operating Instructions SINEAX DME 424/442 in three languages:
German, French, English
- 1 blank type label for recording programmed settings



www.mod-tronic.com | sales@mod-tronic.com | 1-800-794-5883

Appendix 1: PROGRAMMING FOR SINEAX TYPE DME 424



with 2 analog and 4 digital outputs

(see Data Sheet DME 424/442-1 Le, Table 4: "Programming for types DME 424 and 442")

Customer / Agent: _____	Date: _____
Order No. / Item: _____	Delivery date: _____
No. of instruments: _____	
Type of instrument (marking): _____	

A						1. Application System _____	
U						2. Input voltage, rated value Ur = _____	
V						3. Input current, rated value Ir = _____	
W						4. Primary transformer CT = _____ A / _____ A VT = _____ kV / _____ V	
Output A							
A	A					5. Measured variable Type: _____	X0 = _____ X2 = _____
A	B					6. Output signal	Y0 = _____ Y2 = _____
A	C					7. Characteristic linear/bent	X1 = _____ Y1 = _____
A	D					8. Limits	Standard / Ymin = _____ Ymax = _____
Output B							
B	A					9. Measured variable Type: _____	X0 = _____ X2 = _____
B	B					10. Output signal	Y0 = _____ Y2 = _____
B	C					11. Characteristic linear/bent	X1 = _____ Y1 = _____
B	D					12. Limits	Standard / Ymin = _____ Ymax = _____
Output E							
E	A					21. Measured variable Type: _____	Additional information: _____
E	B					22. Output signal (limit contact only)	ON / OFF
E	C					23. Pick-up delay	YDel = _____ s

Output F				
F	A			24. Measured variable Type: _____ Additional information: _____
F	B			25. Output signal (limit contact only) ON / OFF
F	C			26. Pick-up delay YDel = _____ s
Output G				
G	A			27. Measured variable Type: _____ Additional information: _____
G	B			28. Output signal (limit contact only) ON / OFF
G	C			29. Pick-up delay YDel = _____ s
Output H				
H	A			30. Measured variable Type: _____ Additional information: _____
H	B			31. Output signal (limit contact only) ON / OFF
H	C			32. Pick-up delay YDel = _____ s

Appendix 2: PROGRAMMING FOR SINEAX TYPE DME 442



with 4 analog and 2 digital outputs

(see Date Sheet DME 424/442-1 Le, Table 4: "Programming for types DME 424 and 442")

Customer / Agent: _____	Date: _____
Order No. / Item: _____	Delivery date: _____
No of instruments: _____	
Type of instrument (marking): _____	

1. Application			
A <input type="text"/>	System _____		
2. Input voltage, rated value			
U <input type="text"/>	Ur = _____		
3. Input current, rated value			
V <input type="text"/>	Ir = _____		
4. Primary transformer			
W <input type="text"/>	CT = _____ A / _____ A VT = _____ kV / _____ V		
Output A			
A A <input type="text"/>	5. Measured variable Type: _____	X0 = _____	X2 = _____
A B <input type="text"/>	6. Output signal	Y0 = _____	Y2 = _____
A C <input type="text"/>	7. Characteristic linear / bent	X1 = _____	Y1 = _____
A D <input type="text"/>	8. Limits	Standard / Ymin = _____	Ymax = _____
Output B			
B A <input type="text"/>	9. Measured variable Type: _____	X0 = _____	X2 = _____
B B <input type="text"/>	10. Output signal	Y0 = _____	Y2 = _____
B C <input type="text"/>	11. Characteristic linear / bent	X1 = _____	Y1 = _____
B D <input type="text"/>	12. Limits	Standard / Ymin = _____	Ymax = _____
Output C			
C A <input type="text"/>	13. Measured variable Type: _____	X0 = _____	X2 = _____
C B <input type="text"/>	14. Output signal	Y0 = _____	Y2 = _____
C C <input type="text"/>	15. Characteristic linear / bent	X1 = _____	Y1 = _____
C D <input type="text"/>	16. Limits	Standard / Ymin = _____	Ymax = _____

Output D					
D	A				17. Measured variable Type: _____ X0 = _____ X2 = _____
D	B				18. Output signal Y0 = _____ Y2 = _____
D	C				19. Characteristic linear / bent X1 = _____ Y1 = _____
D	D				20. Limits Standard / Ymin = _____ Ymax = _____
Output G					
G	A				21. Measured variable Type: _____ Additional information: _____
G	B				22. Output signal (limit contact only) ON / OFF
G	C				23. Pick-up delay YDel = _____ s
Output H					
H	A				24. Measured variable Type: _____ Additional information: _____
H	B				25. Output signal (limit contact only) ON / OFF
H	C				26. Pick-up delay YDel = _____ s