

- 100 Ω Platinum RTD
- 316 Stainless Steel Probe
- Capture Minimum and Maximum Readings

- Selectable Units
- NEMA 4X Housing
- Fits Standard Thermowells

**Specifications**

**Ranges and Resolution**

-58.0°F to 392.0°F or -50.0°C to 200.0°C  
 Extrapolated range for out-of-range conditions  
 0.1 degree resolution  
 User selectable °F or °C

**Accuracy**

Includes linearity, hysteresis, repeatability  
 ±0.3°C at 0°C, ±1.1°C at 150°C  
 11-point linearization

**Display**

4 readings per second nominal display update rate  
 4 digit LCD, 0.5" H  
 5 character 0.25" H alphanumeric  
 BL models: red LED backlight

Two front panel bi-color red/green LEDs for alarm status indication

ALARM1 temperature over range indication  
 ALARM2 temperature under range indication

**Relay Output**

Two independent SPDT relays  
 0.5A/115VAC, 1A/24VDC, non-inductive  
 Alarm status updated 4 times per second nominal  
 Alarm configuration mode can be pass code protected  
 Each alarm programmable for either HI or LO set point  
 Each alarm programmable for deadband in degrees  
 Selectable upscale or downscale burnout  
 Selectable normal or reverse alarm action  
 Factory defaults: °F temperature scale, SP1 HI, SP2 LO, 1° deadband, downscale burnout, normal alarm action, configuration and test mode not pass code protected.

3 ft long, 6-conductor 22 AWG cable for relays

**Power**

8 to 24 VAC 50/60 Hz or 9 to 32 VDC  
 Reverse polarity protected  
 3 ft long, 2-conductor 22 AWG cable for power

**Sensor**

IEC-751 Class B 100 Ω Platinum RTD, 0.00385 alpha curve  
 ½" NPT male, 316 stainless steel  
 Spring-loaded probe versions fit standard thermowells

**Controls & Functions**

4 button front keypad for setup, calibration, and configuration.  
 Multi-level user-defined pass codes to prevent unauthorized changes.  
 Pass code optional for output test and set point changes.  
 Pass code required for configuration and calibration.

**Output Test Function**

Test mode to toggle alarm relays  
 Output test function can be pass code protected

**Calibration**

User settable pass code required to enter calibration mode  
 Zero and span temperature calibration  
 Non-interactive zero, span, and linearity, ±10% of range

**Weight**

Product: 12 ounces (approximately)  
 Shipping: 1 pound (approximately)

**Housing Material**

ABS/polycarbonate NEMA 4X case, rear gasket, polycarbonate label, aluminum sensor block

**Storage Temperature**

-40 to 203°F (-40 to 95°C)

**Operating Range**

-4 to 185°F (-20 to 85°C) at housing



ThermoPro T16ADA Temperature Alarm

See thermowell manufacturer's specifications. Note that stem length is NOT the same as thermowell insertion depth.

**Dimensions**

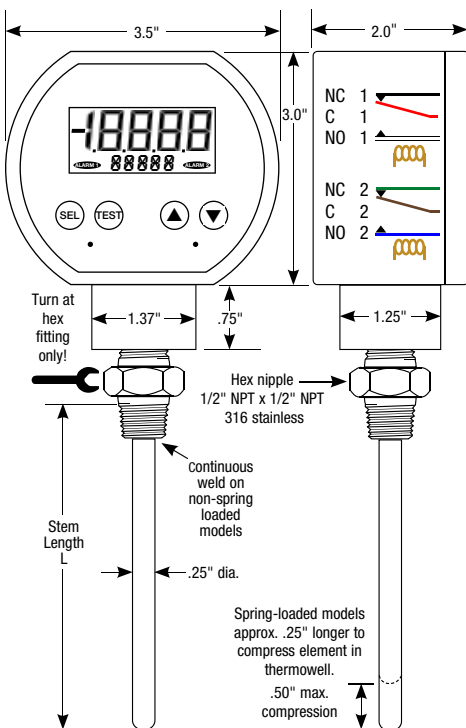

**Wiring**

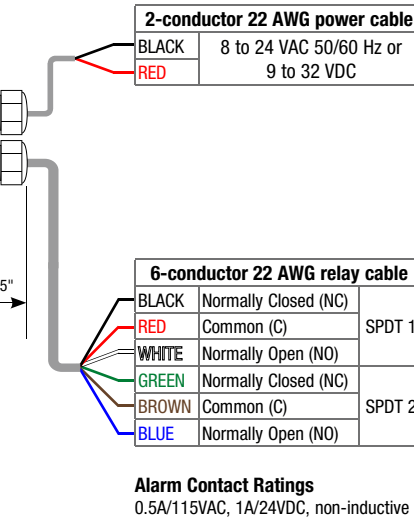

Cecomp maintains a constant effort to upgrade and improve its products. Specifications are subject to change without notice. Consult factory for your specific requirements.

**How to Order**

If you require a certain configuration to be pre-set from the factory, please indicate it on your order.

**Option—add to end of model number**

**-CC** Conformal coating on circuit board for moisture resistance

Model	Length	Backlighting
T16ADA2	2.5" L fixed length	None
T16ADA4	4" L fixed length	
T16ADA6	6" L fixed length	
T16ADA9	9" L fixed length	
T16ADA12	12" L fixed length	
T16ADA2S	2.5" L spring-loaded	
T16ADA4S	4" L spring-loaded	
T16ADA6S	6" L spring-loaded	
T16ADA9S	9" L spring-loaded	
T16ADA12S	12" L spring-loaded	
T16ADABL2	2.5" L fixed length	Red LED display backlight
T16ADABL4	4" L fixed length	
T16ADABL6	6" L fixed length	
T16ADABL9	9" L fixed length	
T16ADABL12	12" L fixed length	
T16ADABL2S	2.5" L spring-loaded	
T16ADABL4S	4" L spring-loaded	
T16ADABL6S	6" L spring-loaded	
T16ADABL9S	9" L spring-loaded	
T16ADABL12S	12" L spring-loaded	

**Precautions**

Read these instructions before installation. Configuration may be easier before installation.

Install or remove thermometer using a wrench on the hex fitting only. Do not attempt to turn by forcing the housing.

Use a thermowell appropriate for the process.

Do not exceed maximum allowable housing temperature.

Due to the hardness of 316 stainless steel, it is recommended that a thread sealant be used to ensure leak-free operation.

**Normal Operation**

To turn the unit on, apply power. If so equipped, the optional display backlighting will be on. The display backlighting will not be apparent under bright lighting conditions.

The display segments are tested for approximately 1 second. During the startup sequence, the alarm relays are de-energized and the alarm status LEDs are off.

The actual temperature and units are displayed and updated approximately 4 times per second.

The factory default configuration is °F, downscale burnout, Setpoint 1 High Alarm, Setpoint 2 Low Alarm, 1.0 degree alarm deadband, normal acting relays, no pass code required for configure/test alarms mode.

After power-up, the display, the alarm relay states will correspond to the temperature of the RTD probe.

**Display and Keypad**

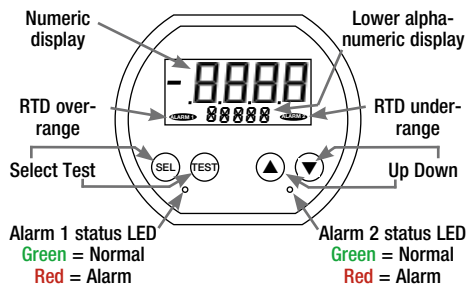

**Display Out-of-Range Indications**

RTD over-range condition >392.0°F or >200.0°C 

RTD under-range condition <-58.0°F or <-50.0°C 

If the RTD temperature is outside of the extrapolated range, a burnout condition will be assumed.

1. . . . if upscale burnout is selected

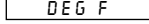

-1. . . . if downscale burnout is selected.

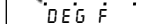

**Alarm Indications**

The relevant bi-color LED will be illuminated green for a normal condition or red for an alarm condition.

The red LED will blink at a slow rate until the alarm is acknowledged or the alarm condition clears.

To acknowledge an alarm condition, press and release the TEST button.

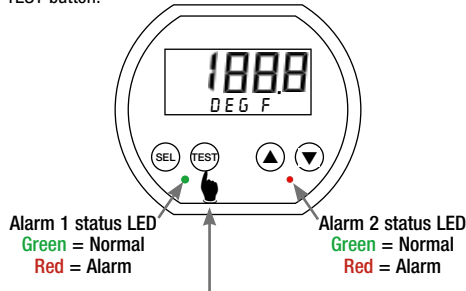

Red blinking LED = unacknowledged alarm  
Press Test to acknowledge blinking alarm

**Viewing Alarm Trip Points**

The RTD temperature, the value of Trip Point 1, and the value of Trip Point 2 may be selected for display as follows.

When the RTD temperature is being displayed, press and release the SEL (select) button. The Trip Point 1 value will be displayed with TRIP1 on the lower display.



When the Trip Point 1 value is being displayed, press and release the SEL button. The Trip Point 2 value will be displayed with TRIP2 on the lower display.

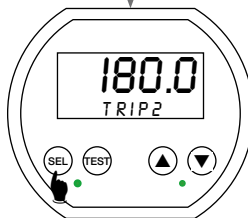

When the Trip Point 2 value is being displayed, press and release the SEL button. The RTD temperature will be displayed.

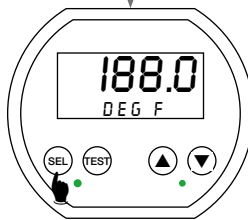

**Alarm Test Mode (continued)**

While in the Alarm Test Mode with no buttons pressed, the display will indicate the temperature with DEG C or DEG F slowly blinking on the lower display.

Blinking temperature units indicates Alarm Test Mode.

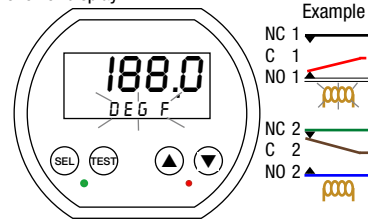

While the TEST button is pressed and held, both LED indicators and alarm relays will toggle to their opposite state. The display will continue to indicate the temperature.

Alarm LEDs and relays toggle to opposite state.

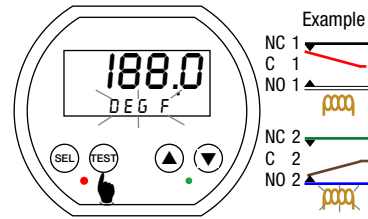

To exit the Alarm Test Mode, press and release the SEL button. The display briefly indicates - - - - and then returns to normal operation.

**Adjusting Set Point 1**

Alarm 1 factory default: HI alarm, 392.0°F trip point.

From the normal mode press the SEL button to display Trip Point 1. Release the SEL button.

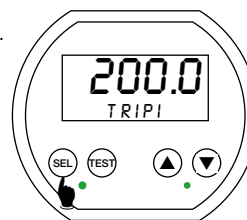

While TRIP1 is displayed, press and hold the TEST button and then press the SEL button.

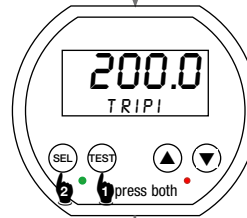

Release both buttons when the display indicates - - - -.

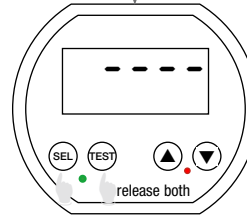

If pass code protection is enabled, before the unit enters the Alarm Test Mode, the display indicates - - - - with the left-most underscore blinking, and with TSTPC on the lower display. Enter the user-defined pass code (3510 factory default) as described in the Pass Code Entry section.

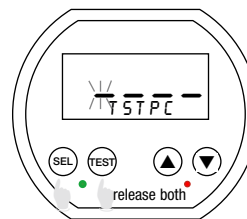

Note: During pass code entry the LEDs will turn off and the unit will not respond to changes in RTD temperature. The alarm relays will maintain their prior states. The unit will automatically revert to normal operation if no buttons are operated for approximately 15 seconds.

Continued...

**Alarm Test Mode**

This mode allows testing of the alarms regardless of the alarm trip points or the temperature reading.

From the normal mode with temperature being displayed, press and hold the TEST button and then press the SEL button.

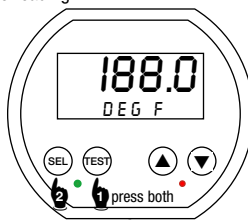

Release both buttons when the display indicates - - - -.



If pass code protection is enabled, before the unit enters the Alarm Test Mode, the display initially indicates - - - - with the left-most underscore blinking, and with TSTPC on the lower display. Enter the user-defined pass code (3510 factory default) as described in the Pass Code Entry section.

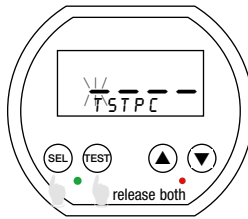

**Adjusting Set Point 1 (continued)**

While in the Set Point 1 Adjust Mode, the display will indicate Trip Point 1 with TRIP1 blinking at a slow rate on the lower display.

To adjust Set Point 1, press and hold the TEST button and the display will indicate SP1 on the lower display. If the alarm is not tripped the display will change by an amount equal to the deadband value.

While holding the TEST button operate the ▲ and ▼ buttons to adjust Set Point 1 to the desired value. The Set Point 1 value is stored when the TEST button is released.

Note that the unit will not respond to changes in temperature, LEDs are turned off, and the alarm relays will maintain their prior states while the TEST button is held.

To exit the Set Point 1 Adjust Mode, press and release the SEL button. The display briefly indicates - - - - and then returns to normal operation.

"Set Point" is defined as the temperature that will result in a change of state only from a normal to an alarm condition. "Trip Point" is defined as the value of RTD temperature that will result in a change of state of alarm condition, and includes the effect of deadband when returning from an alarm to a normal condition.

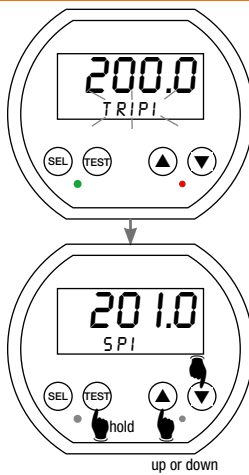

**Adjusting Set Point 2 (continued)**

During pass code entry the LEDs will turn off and the unit will not respond to temperature changes. The alarm relays will maintain their prior states. The unit will automatically revert to normal operation if no buttons are pushed for 15 seconds.

While in the Set Point 2 Adjust Mode, the display will indicate Trip Point 2 with TRIP2 blinking at a slow rate on the lower display.

To adjust Set Point 2, press and hold the TEST button and the display will indicate SP2 on the lower display. If the alarm is not tripped the display will change by an amount equal to the deadband value.

While holding the TEST button operate the ▲ and ▼ buttons to adjust Set Point 2 to the desired value. The Set Point 2 value is stored when the TEST button is released.

Note that the unit will not respond to changes in temperature, LEDs are turned off, and the alarm relays will maintain their prior states while the TEST button is held.

To exit the Set Point 2 Adjust Mode, press and release the SEL button. The display briefly indicates - - - - and then returns to normal operation.

"Set Point" is defined as the temperature that will result in a change of state only from a normal to an alarm condition. "Trip Point" is defined as the value of RTD temperature that will result in a change of state of alarm condition, and includes the effect of deadband when returning from an alarm to a normal condition.

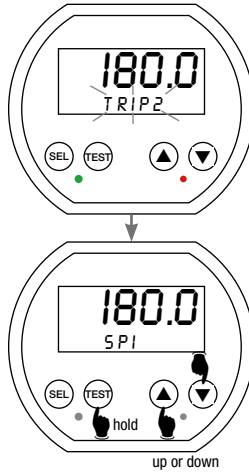

**Adjusting Set Point 2**

Alarm 2 factory default: LO alarm, -58.0°F trip point.

From the normal mode press the SEL button until Trip Point 2. Release the SEL button.

While TRIP1 is displayed, press and hold the TEST button and then press the SEL button.

Release both buttons when the display indicates - - - -.

If pass code protection is enabled, before the unit enters the Alarm Test Mode, the display indicates - - - - with the left-most underscore blinking, and with TSTPC on the lower display. Enter the user-defined pass code (3510 factory default) as described in the Pass Code Entry section.

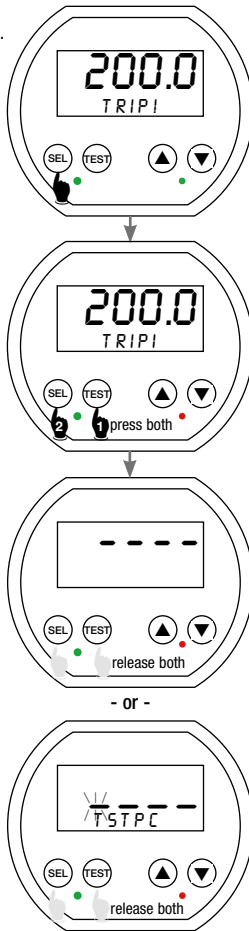

**Pass Code Entry**

Before the unit enters a pass code protected mode, the display initially indicates - - - - with the first underscore blinking, and with CFGPC, CALPC, or TSTPC on the lower display, depending on how the mode was entered.

Note that the unit will not respond to changes in temperature, LEDs are turned off, and the alarm relays will maintain their prior states while in the pass code entry mode.

The unit will automatically revert to normal operation if no buttons are operated for approximately 15 seconds.

Enter the user-defined pass code (3510 factory default).

Use the ▲ and ▼ buttons to increase or decrease the numerical value.

Press and release the SEL button to index to the next position.

Once the 4-digit user-defined pass code has been entered, press and release the SEL button to proceed to the specific mode of operation.

Note: If an incorrect pass code was entered, the unit will exit to the normal operating mode.

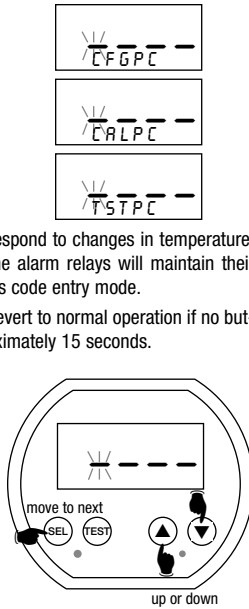

**Pass Code Modification**

During pass code entry the LEDs will turn off and the unit will not respond to temperature changes. The alarm relays will maintain their prior states. The unit will automatically revert to normal operation if no buttons are pushed for 15 seconds.

**Configuration Pass Code**

From the normal operating mode press and hold the TEST and the ▲ buttons. Then press the SEL button. Release all buttons when the display indicates CFG. The display initially indicates - - - - with the first underscore blinking, and with CFGPC on the lower display.

**Calibration Pass Code**

Press and hold the TEST and the ▼ buttons. Then press the SEL button. Release all buttons when the display indicates CAL. The display initially indicates - - - - with the first underscore blinking, and with CALPC on the lower display.

**Test and Set Point Adjust Pass Code (optional)**

The option for pass code protected alarm testing or set point changes is set in CFG mode.

Press and hold the TEST button. Then press the SEL button. Release all buttons when the display indicates - - - -.

If TSTPC pass code is enabled, the display indicates - - - - with the first underscore blinking, and TSTPC on the lower display.

**Factory Pass Code Entry (1220 factory default)**

Use the ▲ and ▼ buttons to increase or decrease the numerical value.

Press and release the SEL button to index to the next position.

Once the 4-digit user-defined pass code has been entered, press and release the SEL button to proceed. If an incorrect pass code was entered, the unit will exit to the normal operating mode.

Once the correct password has been entered, the display will indicate the existing pass code with CFGPC, CALPC, or TSTPC on the lower display.

Operate the ▲ or ▼ button to select the first character of the new pass code. Press and release the SEL button to proceed to the next character. Repeat until the entire pass code is complete. Write down the new pass code in a secure place.

To exit the Pass Code Modification mode, press and hold the SEL button. Release the button when the display indicates - - - - to restart the unit in the normal mode.

The unit proceeds through a restart sequence during which all active display segments are turned on for approximately 1 second. During the restart sequence, the alarm relays are de-energized and the alarm status LEDs are off.

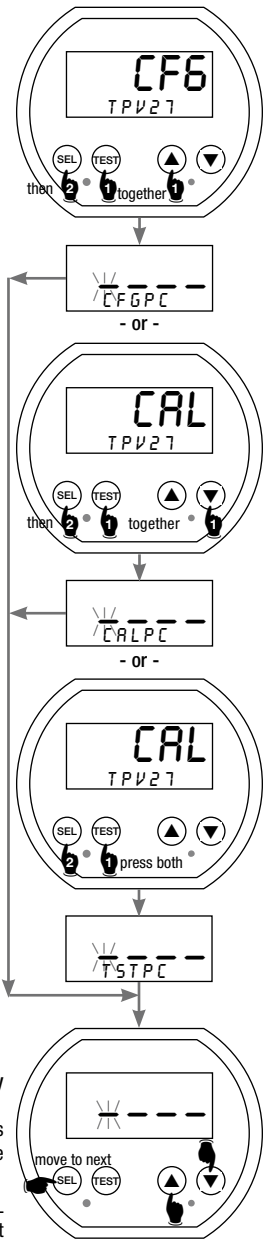

**Calibration**

Temperature calibration is performed at two points: ice point and at a temperature above ice point. For general service, the full scale temperature is normally used for the second point. However, if a particular temperature is of critical interest, it may be used instead for greatest accuracy at that point. When the applied temperature is below approximately 12 °C (or 54 °F), the unit will automatically select the ice-point calibration mode.

**Entering Calibration Mode**

From the normal mode with RTD temperature being displayed, press and hold the TEST and the ▼ buttons. Then press the SEL button. Release all buttons when the display indicates CAL.

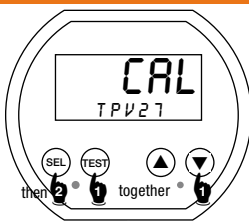

Enter the user-defined pass code (3510 factory default) as described in the Pass Code Entry section.



Upon successful pass code entry, the upper segments of the display will indicate the RTD probe temperature. The lower segments of the display will alternate as indicated below.

Note: To store the calibration parameters and exit calibration mode at any time, press and hold the SEL button until the display indicates - - - - .

**Ice-Point Calibration**

Apply 0.0°C or 32.0°F to the RTD. The lower display segments will alternate between ICE and DEG C or DEG F.

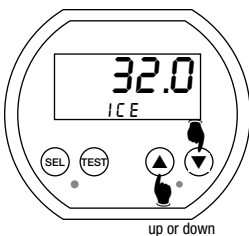

Use the ▲ and ▼ buttons to adjust the upper display segments to indicate 0.0°C or 32.0°F.

**Span Calibration**

Apply full-scale temperature to the RTD. The lower display segments will alternate between CAL and DEG C or DEG F.

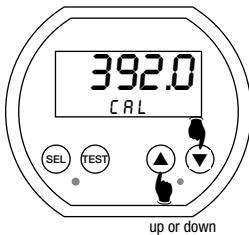

Use the ▲ and ▼ buttons to adjust the upper display segments to indicate the applied temperature value.

**Exit and Save**

To store the calibration parameters and exit calibration mode, press and continue to hold the SEL button until the display indicates - - - - .

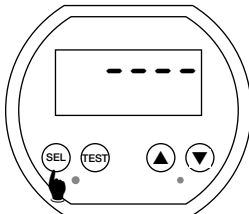

**Entering User Configuration Mode**

Note: Whether or not configuration changes are made, all alarm set points will be reset to the maximum and minimum values respectively upon exit from the configuration mode.

From the Normal Mode with RTD temperature being displayed, press and hold the TEST and the ▲ buttons. Then press the SEL button. Release all buttons when the display indicates CFG.

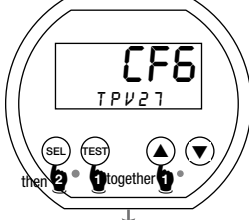

Enter the user-defined pass code (3510 factory default) as described in the Pass Code Entry section.



**Temperature Scale Selection**

The upper display will be blank, and the lower section will display either DEG C or DEG F.

To change from degrees Celsius to Fahrenheit, press and release the ▲ button. The lower display will change to DEG F.

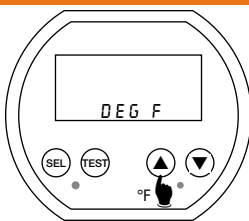

To change from degrees Fahrenheit to Celsius, press and release the ▼ button. The lower display will change to DEG C.

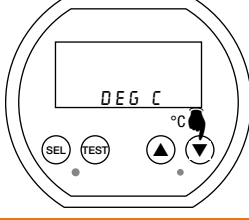

Press and release the SEL button to move on to the next parameter.

**Upscale/Downscale Burnout Action**

The upper display will be blank, and the lower section will display either DN BO or UP BO.

To change from Downscale Burnout to Upscale Burnout, press and release the ▲ button. The lower display will change to UP BO.

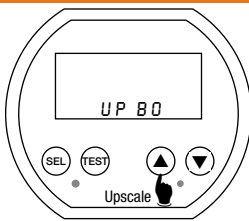

To change from upscale burnout to downscale burnout, press and release the ▼ button. The lower display will change to DN BO.

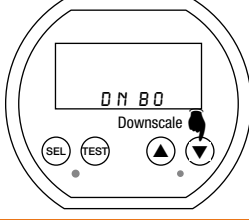

Press and release the SEL button to move on to the next parameter.

**Set Point 1 LO or HI**

The upper display will be blank, and the lower section will display either SP1LO or SP1HI.

To configure Setpoint 1 as a High Alarm, press and release the ▲ button. The lower section of the display will indicate SP1HI.

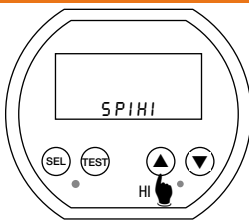

To configure Setpoint 1 as a Low Alarm, press and release the ▼ button. The lower section of the display will indicate SP1LO.

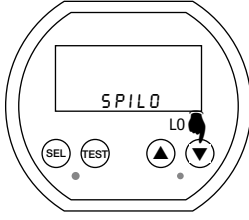

Press and release the SEL button to move on to the next parameter.

**Set Point 2 LO or HI**

The upper display section will be blank, and the lower section will display either SP2LO or SP2HI.

To configure Setpoint 2 as a High Alarm, press and release the ▲ button. The lower section of the display will indicate SP2HI.

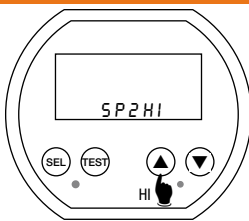

To configure Setpoint 2 as a Low Alarm, press and release the ▼ button. The lower section of the display will indicate SP2LO.

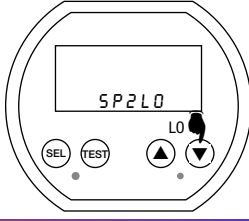

Press and release the SEL button to move on to the next parameter.

**Alarm Action**

The upper display section will be blank, and the lower section will display either NOR or REV.

To configure the relays for reverse action, press and release the ▲ button. The lower section of the display will indicate REV.

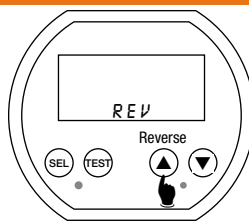

To configure the relays for normal action, press and release the ▼ button. The lower section of the display will indicate NOR.

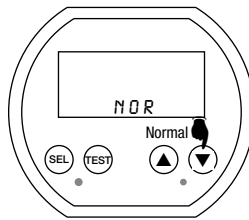

Press and release the SEL button to move on to the next parameter.

**Set Point 1 Deadband**

The upper display will indicate the Setpoint 1 deadband in °C or °F, and the lower section will display SP1DB.

Use the ▲ and ▼ buttons to set the desired Setpoint 1 deadband value.

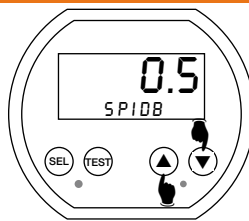

Press and release the SEL button to move on to the next parameter.

**Set Point 2 Deadband**

The upper display will indicate the Setpoint 2 deadband in °C or °F, and the lower section will display SP2DB.

Use the ▲ and ▼ buttons to set the desired Setpoint 2 deadband value.

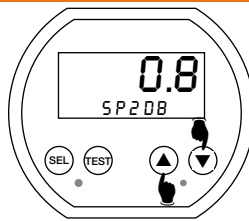

Press and release the SEL button to move on to the next parameter.

**Test Mode and Set Point Security**

The upper display will be blank, and the lower section will display either TSTPC or NOTPC.

To enable Test and Set Point Adjust Mode pass code protection, press and release the ▲ button. The lower section of the display will indicate TSTPC.

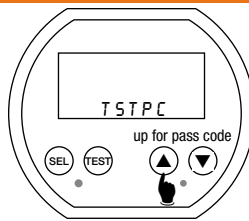

To disable Test and Set Point Adjust Mode pass code protection, press and release the ▼ button. The lower section of the display will indicate NOTPC.

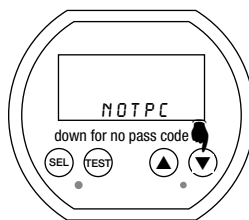

**Save Settings and Exit**

Press and release the SEL button to save the configuration parameters and restart the unit. Note: The configuration parameters will not be saved if the procedure is interrupted before completion.

The unit proceeds through a restart sequence during which all active display segments are turned on for approximately 1 second. During the restart sequence, the alarm relays are de-energized, the alarm status LEDs are off.