

SINEAX U 554

Transducer for AC Voltage with Different Characteristics

With power supply
RMS value measurement
Carrying rail housing P13/70



Application

The transducer **SINEAX U 554** (Fig. 1) converts a sinusoidal or a distorted AC voltage into a **load independent** DC current or a **load independent** DC voltage proportional to the measured value. Depending on the version, part of the measuring range of interest may be amplified at the beginning or end. The section of no or minor interest is suppressed. A live zero output signal is possible with all versions (see Fig. 3 and 4).

The transducer fulfils all the important requirements and regulations concerning electromagnetic compatibility **EMC** and **Safety** (IEC 1010 resp. EN 61 010). It was developed and is manufactured and tested in strict accordance with the **quality assurance standard** ISO 9001.



Fig. 1. Transducer SINEAX U 554 in housing P13/70 clipped onto a top-hat rail.

Features / Benefits

- Measuring input: AC voltage, sine or distorted wave forms, true RMS value measurement

Measured variable	Measuring range limits
AC voltage	0 to 20 to 0 to 690 V

- Measuring output: Unipolar and live-zero output variables
- Measuring principle: Logarithmic method
- DC, AC-power pack with wide power supply tolerance

Mode of operation

Input signal U_{\sim} is galvanically separated from the mains network using a transformer.

The following mathematical expression is then formed using a root-mean-square value computer

$$U_{\text{eff}} = \sqrt{\frac{1}{T} \int_0^T u^2 dt}$$

Following filtration by means of an active filter, the transformation properties of the measuring transducer are determined in the succeeding characteristics circuit.

The output amplifier transforms the measuring signal into an impressed output signal A.

The electronic components are supplied with voltage H from the mains supply unit H.

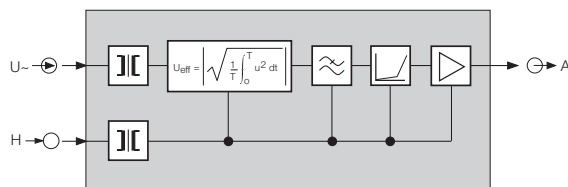

Fig. 2. Block diagram.

Technical data

General

Measured quantity: AC voltage
Sine or distorted wave form
True RMS value measurement

Measuring principle: Logarithmic method

Measuring input E

Nominal frequency f_N : 50/60 or 400 Hz

Nominal input voltage U_N
(measuring range end value): 0 to 20 to 0 to 690 V

Own consumption: ≤ 1 VA with input end value

Overload capacity:

Measured quantity U_N	Number of applications	Duration of one application	Interval between two successive applications
$1.2 \cdot U_N^1$	---	continuously	---
$2 \cdot U_N^1$	10	1 s	10 s

¹ But max. 264 V with power supply from measuring input

Measuring output A

Load-independent
DC current: 0 to 1 to 0 to 20 mA
resp. live-zero
0.2 to 1 to 4 to 20 mA

SINEAX U 554

Transducer for AC Voltage with Different Characteristics

Burden voltage:	15 V
External resistance:	$R_{\text{ext max.}} [\text{k}\Omega] = \frac{15 \text{ V}}{I_{\text{AN}} [\text{mA}]}$ $I_{\text{AN}} = \text{Output current end value}$
Load-independent DC voltage:	0 to 1 to 0 to 10 V resp. live-zero 0.2 to 1 to 2 to 10 V
External resistance:	$R_{\text{ext min.}} [\text{k}\Omega] \geq \frac{U_A [\text{V}]}{4 \text{ mA}}$
Residual ripple in output current:	$\leq 1.5 \cdot I_{\text{AN}}$ at current output Approx. 10 mA at voltage output
Voltage limit under $R_{\text{ext}} = \infty$:	$\leq 25 \text{ V}$
Residual ripple in output current:	$\leq 1\%$ p.p. at setting time 300 ms $\leq 5\%$ p.p. at setting time 50 ms and $c \leq 2.5$ $\leq 5\%$ p.p. + $c \times 0.5\%$ at setting time 50 ms and $c > 2.5$
Setting time:	50 ms or 300 ms

Power consumption: $\leq 3 \text{ VA}$ at $H = U_N$

DC, AC-power pack (DC or 40 to 400 Hz)

Table 1: Rated voltages and permissible variations

Nominal voltage U_N	Permissible variation
85 to 230 V DC, AC	DC - 15 to + 33%
24 to 60 V DC, AC	AC $\pm 15\%$

Option: Connected to the low tension terminal side 12 and 13
24 V AC or 24 to 60 V DC

Power consumption: $\leq 2 \text{ W}$ resp. $\leq 4 \text{ VA}$

Accuracy (acc. to EN 60 688)

Reference value: Output end value
Basic accuracy: Class 0.5 with setting time 300 ms
Class 0.5 x c with setting time 50 ms

Factor c: $c = \frac{E3}{E2}$
with main value magnification in initial range
 $c = \frac{1}{1 - E2/E3}$
with main value magnification in end range

Reference conditions:

Ambient temperature: 15 to 30 °C
Input variable: Rated operating range
Frequency: $f_N \pm 2 \text{ Hz}$
Curve shape: Sine-wave
Crest factor: $\sqrt{2}$
Power supply: In rated range
Output burden: Current: $0.5 \cdot R_{\text{ext max.}}$
Voltage: $2 \cdot R_{\text{ext min.}}$
Warm-up time: $\leq 5 \text{ min.}$

Influence effects (maxima):

Setting time 300 ms: $c = 1$
Setting time 50 ms: c acc. to calculation
Frequency influence: 40 to 400 Hz, $\pm 0.3\% \times c$
30 to 1000 Hz, $\pm 0.5\% \times c$
Crest factor: 1 to 2.5, $\pm 0.2\% \times c$
> 2.5 to 6, $\pm 0.5\% \times c$

Influence quantity	Rated operating range	Permitted effect as factor of precision class
Ambient temperature	- 10 to 15 to 30 to 40°C	1
	10 to 15 to 30 to 55°C	3

Output characteristics

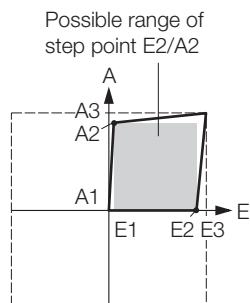

Fig. 3. Characteristic A:
 $E1 = 0$
 $0.1 \times E3 \leq E2 \leq 0.9 \times E3$
 $A1 = 0$
 $A1 \leq A2 \leq 0.9 \times A3$

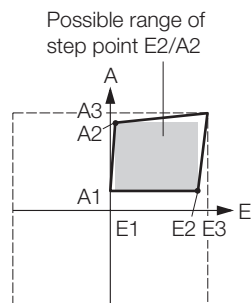

Fig. 4. Characteristic B:
 $E1 = 0$
 $0.1 \times E3 \leq E2 \leq 0.9 \times E3$
 $A1 = 0.2 \times A3$
 $A1 \leq A2 \leq 0.9 \times A3$

Power supply H $\rightarrow \bigcirc$

Nominal voltage U_N	Rated operating range
AC 24 V	22 to 26 V
AC 110 V	99 to 121 V
AC 115 V	103 to 127 V
AC 120 V	108 to 132 V
AC 230 V	207 to 253 V
AC 400 V	360 to 440 V

Rated operating range of frequency: 45 to 50 to 60 to 65 Hz

Safety

Protection class:	II (protection isolated, EN 61 010)
Housing protection:	IP 40, housing (test wire, EN 60 529) IP 20, terminals (test finger, EN 60 529)
Contamination level:	2
Overvoltage category:	III
Rated insulation voltage (versus earth):	400 V, input 230 V, power supply 40 V, output
Test voltage:	50 Hz, 1 min. acc. to EN 61 010-1 3700 resp. 5550 V, input versus all other circuits as well as outer surface 3700 V, power supply versus output as well as outer surface 490 V, output versus outer surface

Installation data

Mechanical design:	Housing P13/70
Material of housing:	Lexan 940 (polycarbonate), flammability Class V-0 acc. to UL 94, self-extinguishing, non-dripping, free of halogen
Mounting:	For rail mounting
Mounting position:	Any
Weight:	Approx. 0.3 kg

Connecting terminals

Connection element:	Screw-type terminals with indirect wire pressure
Permissible cross section of the connection leads:	≤ 4.0 mm ² single wire or 2 × 2.5 mm ² fine wire

Environmental conditions

Operating temperature:	- 10 to + 55 °C
Storage temperature:	- 40 to +70 °C
Relative humidity of annual mean:	≤ 75%

Ambient tests

EN 60 068-2-6:	Vibration
Acceleration:	± 2 g
Frequency range:	10 to 150 to 10 Hz, rate of frequency sweep: 1 octave / minute
Number of cycles:	10, in each of the three axes
EN 60 068-2-27:	Shock
Acceleration:	3 x 50 g 3 shocks each in 6 directions
EN 60 068-2-1/-2/-3:	Cold, dry heat, damp heat
IEC 1000-4-2/-3/-4/-5/-6 EN 55 011:	Electromagnetic compatibility

Table 2: Specification and ordering informations

Description	Blocking code	no-go with blocking code	Article No./ Feature
Transducer for AC voltage with different characteristics			554 -
Order Code 554 - 4xxx xxxx xx			
Features, Selection			
1. Mechanical design Housing P13/70 for rail mounting			4
2. Nominal input frequency Nominal frequency 50/60 Hz			1
Nominal frequency 400 Hz			3
3. Input voltage, final value Final value E3 ≥ 20 V to ≤ 690 V* [M] <input type="text"/>			Z
With power supply from measuring input min. 24 V / max. 230 V, see feature 8. * > 400 V for connection between 2 phases in 3-phase system only			
4. Input voltage, step point Step point E2 E2, permissible values: 0.1 · E3 to 0.9 · E3 [M] <input type="text"/>			Z

SINEAX U 554

Transducer for AC Voltage with Different Characteristics

Description	Blocking code	no-go with blocking code	Article No./ Feature
Transducer for AC voltage with different characteristics			554 -
Features, Selection			
5. Output signal, initial value			
Initial value A1: 0 (standard)	A		1
Initial value A1: 20% of final value A3 (live-zero)	B		2
6. Output signal, final value			
Final value A3: 1 mA			1
Final value A3: 5 mA			2
Final value A3: 10 mA			3
Final value A3: 20 mA			4
Non-standard [mA] <input type="text"/>			9
> 1 to < 20 mA			
Final value A3: 10 V			A
Non-standard [V] <input type="text"/>			Z
> 1 to < 10 V			
7. Output signal, step point			
Without step point (A2 = A1)			0
Standard step point, A2: [mA, V] <input type="text"/>		B	A
A2, permissible values: > 0 to 0.9 · A3			
Live-zero step point, A2: [mA, V] <input type="text"/>		A	B
A2, permissible values: > 0.2 · A3 to 0.9 · A3			
Specify step point A2 in mA or V, acc. to selection of A3 in feature 6			
8. Power supply			
AC 24 V (22 to 26 V)			1
AC 110 V (99 to 121 V)			2
AC 115 V (104 to 126 V)			3
AC 120 V (108 to 132 V)			4
AC 230 V (207 to 253 V)			5
AC 400 V (360 to 440 V)			6
24 to 60 V DC, AC			A
85 to 230 V DC, AC			B
Power supply from measuring input (≥ 24 to 60 V AC)			C
Power supply from measuring input (≥ 85 to 230 V AC)			D
Uh: 24 V AC / 24 to 60 V DC, low terminal side			E
9. Setting time			
Setting time 0.3 s			1
Setting time 50 ms			2
10. Test certificate			
Without test certificate			0
Test certificate in German			D
Test certificate in English			E

Electrical connections

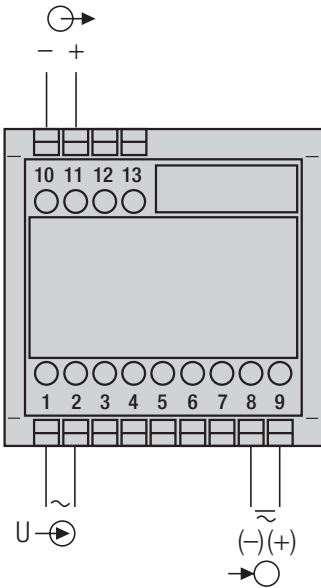

Fig. 5. Power supply connected to terminals 8 and 9.

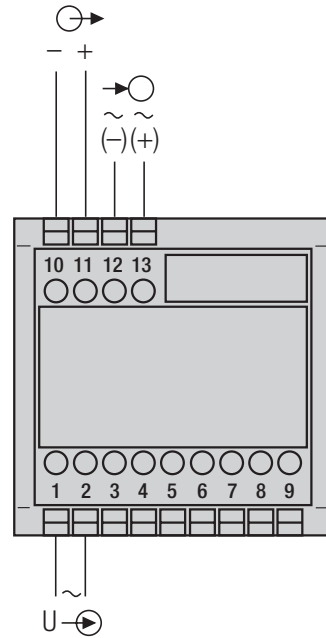

Fig. 7. Power supply connected to the low tension terminal side 12 and 13.

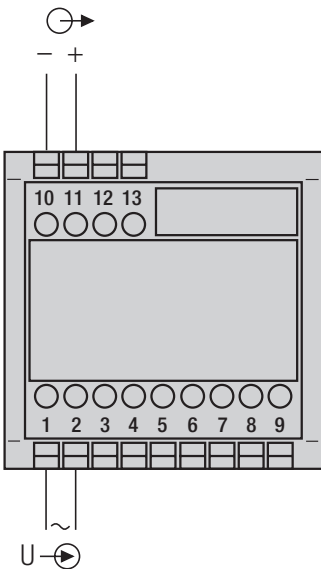

Fig. 6. Power supply internal from voltage measuring input, No power supply connection needed.

- = Measuring input
- = Measuring output
- = Power supply

SINEAX U 554

Transducer for AC Voltage with Different Characteristics

Dimensional drawing

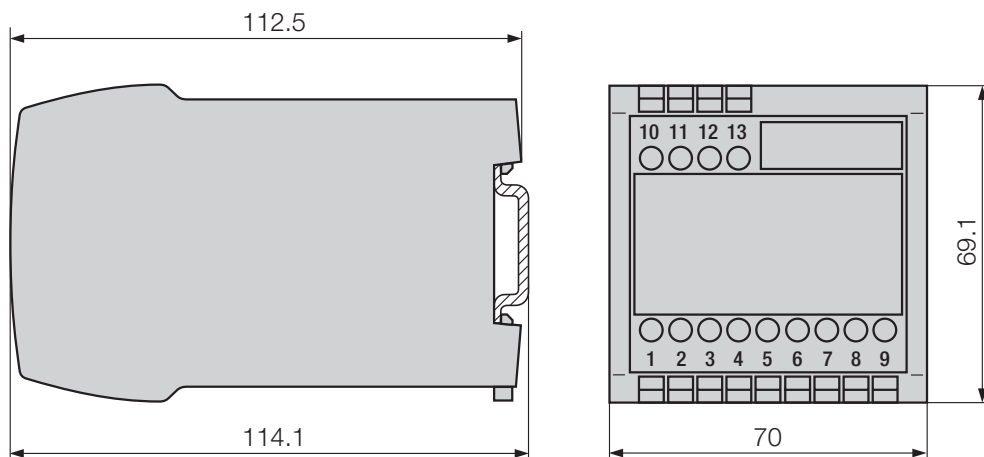

Fig. 8. SINEAX U 554 in housing **P13/70** clipped onto a top-hat rail (35 × 15 mm or 35 × 7.5 mm, acc. to EN 50 022).

Standard accessories

1 Operating Instructions in three languages: German, French, English



SINEAX U 554

Transducer for AC Voltage with Different Characteristics

Printed in Switzerland • Subject to change without notice • Edition 10.02 • Data sheet No. U 554 Le

MOD-TRONIC
INSTRUMENTS LIMITED

48 Haggert Ave N
Brampton, ON L6X 1Y3
Tel: 905 457-6322
Fax: 905 457-4716
Toll Free: 800 794-5883