

DC to DC Isolator Field Rangeable Transmitter

API 4385 G

Input: 0-50 mV to ± 10 VDC, 0-1 mA to 0-20 mA
Output: 0-1 V to ± 10 VDC or 0-2 mA to 4-20 mA

- Non-Interactive Zero & Span
- External Switches & Tables for Range Selection
- One Minute Field Setup for Hundreds of I/O Ranges
- 2000 V Isolation Input/Output/Power
- I/O LoopTracker® LEDs and Functional Test Pushbutton

Applications

- Isolate, Convert, Boost, Rescale Process Signals
- One Model to Interface Process Signals with Panel Meters, Recorders, Data Acquisition Cards, PLCs, DCS Systems, SCADA Systems

Specifications

Input Ranges

Consult factory for optional switch selectable ranges within input & output limits
 System voltages must not exceed socket voltage rating

	Minimum	Maximum
Voltage:	0 to 50 mV	0-20 V
Bipolar Voltage:	± 50 mV	± 10 V
Current:	0 to 200 μ A	0 to 40 mA
Offset:	$\pm 100\%$ maximum, $\pm 75\%$ maximum for 40 mA input	

Input Impedance

Voltage:	1 M Ω minimum
Current:	50 Ω typical
	Input voltage burden (current) 1 VDC at 20 mA

Input Loop Power Supply

18 VDC nominal, unregulated, 25 mADC, max. ripple, less than 1.5 V_{p-p}

LoopTracker

Variable brightness LEDs indicate input and output loop levels and status

Output Ranges

	Minimum	Maximum	Load Factor
Voltage:	0-1 VDC	0-10 VDC	
Bipolar Voltage:	± 1 VDC	± 10 VDC	
Current (20 V compliance):	0-2 mADC	0-20 mADC	1000 Ω at 20 mA

Internal jumper for output reversal. Consult factory for special ranges.

Output Zero and Span

Multiturn potentiometers to compensate for load and lead variations
 $\pm 15\%$ of span adjustment range typical

Output Linearity

Better than $\pm 0.1\%$ of span

Output Ripple and Noise

Less than 10 mV_{RMS}

Functional Test Button

Sets output to test level when pressed. Adjustable 0-100% of span.
 Potentiometer factory set to approximately 50% of span.

Response Time

Standard:	70 milliseconds typical
High Speed:	5 milliseconds typical with DF option

Isolation

2000 V_{RMS} minimum
 Full isolation: power to input, power to output, input to output

Ambient Temperature Range and Temperature Stability

-10°C to +60°C operating ambient
 Better than $\pm 0.02\%$ of span per °C temperature stability

Power

Standard:	115 VAC $\pm 10\%$, 50/60 Hz, 2.5 W max.
A230 option:	230 VAC $\pm 10\%$, 50/60 Hz, 2.5 W max.
D option:	9-30 VDC, 2.5 W typical

© Absolute Process Instruments, Inc. 11/04 LoopTracker—Reg TM Absolute Process Instruments, Inc.



**Wide Ranging I/O
One Minute Setup!**

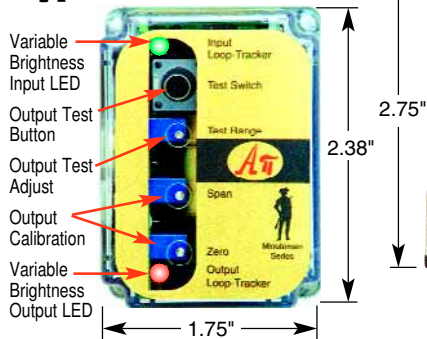

2.75"

2.38"

1.75"



Socket Sold Separately



**Free Factory
Input & Output
Calibration!**



Description and Features

The **API 4385 G** accepts a DC voltage or current input and provides an optical-ly isolated DC voltage or current output that is linearly related to the input. Typical applications include signal isolation, signal conversion, signal boosting or a combination of the three.

The optical isolation between input and output makes this module useful for ground loop elimination, common mode signal rejection or noise pickup reduction. The module power supply is isolated, resulting in full 3-way (input, output, power) isolation.

The **API 4385 G** input, output and zero offset can be field-configured via external rotary and slide switches. Zero offset is adjustable in 15% increments to a maximum of $\pm 100\%$ of span. Common range settings are on the module label. Non-interactive zero and span adjustments simplifies calibration. Output reversal (4-20 mA input to 20-4 mA output) can be changed via an internal jumper.

API exclusive features include two **LoopTracker** LEDs and a **Functional Test Pushbutton**. The LoopTracker LEDs (Green for input, Red for output) vary in intensity with changes in the process input and output signals. Monitoring the state of these LEDs can provide a quick visual picture of your process loop at all times.

The functional test pushbutton provides a fixed output (independent of the input) when held depressed. The test output level can be field-adjusted via a multiturn potentiometer. Both the LoopTracker LEDs and functional test pushbutton greatly aid in saving time during initial startup and/or troubleshooting.

The built-in 18 VDC unregulated loop excitation power supply can be used to power passive input devices. The **API 4385 G** plugs into an industry standard 8-pin octal socket sold separately. Sockets **API 008** and finger-safe **API 008 FS** allow either DIN rail or panel mounting.

Models & Options

API 4385 G Field rangeable DC to DC transmitter, isolated, with loop power supply, 115 VAC

Options—Add to end of model number

A230	Powered by 230 VAC, 50/60 Hz
D	Powered by 9-30 VDC
M01	Input/output reversal, such as 4-20 mA in to 20-4 mA out
DF	Fast response, 1 millisecond nominal response time
U	Conformal coating for moisture resistance

Accessories—Order as separate line item

API 008	8-pin socket
API 008 FS	8-pin finger-safe socket
API TK36	DIN rail, 35 mm W x 39" L, aluminum

MOD-TRONIC
INSTRUMENTS LIMITED

1 Delta Park Blvd #12
 Brampton, ON L6T 5G1
 905-457-6322 or 800-794-5883
 www.mod-tronic.com

DC Input



DC Input

ELECTRICAL CONNECTIONS

WARNING! All wiring must be performed by qualified personnel only. This module requires an industry-standard 8-pin socket. Order API 008 or finger-safe API 008 FS socket.

Power Input Terminals – The white label on the side of the API module will indicate the power requirements. AC power is connected to terminals 1 and 3. For DC powered modules, polarity MUST be observed. Positive (+) is wired to terminal 1 and negative (-) is wired to terminal 3.

Powered Signal Input – Polarity must be observed when connecting the signal input. The positive connection (+) is applied to terminal 5 and the negative (-) is applied to terminal 6.

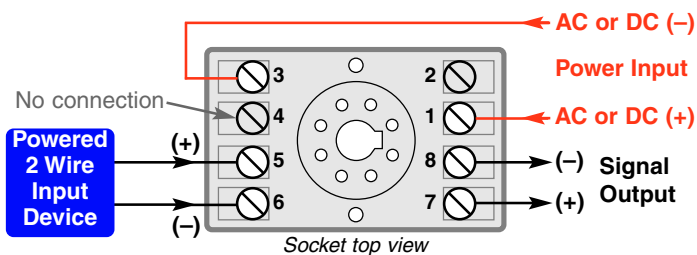

Connecting an input device which provides power to the input circuit

Passive Signal Input – Polarity must be observed when connecting the signal input. A passive input device can be powered by the 18 volt DC power supply at terminal 4. This may save the expense of purchasing a separate power supply for the input device. A typical example is shown, however it is very important to consult the manufacturer of your specific sensor to determine its compatibility and proper wiring.

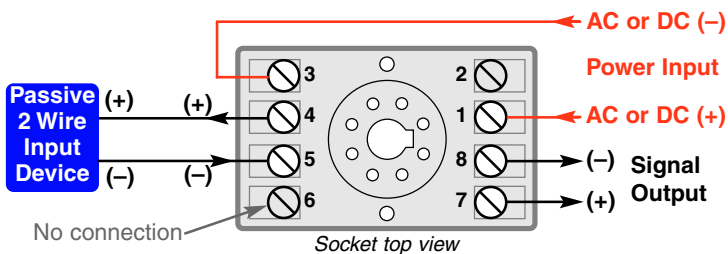

Using the built-in 18 VDC loop supply to power a passive input device

Signal Output Terminals – Polarity must be observed when connecting the signal output to the load. The positive connection (+) is connected to terminal 7 and the negative (-) is connected to terminal 8.

RANGE SELECTION

Three rotary switches and two slide switches located on the side of the module are used to select input and output ranges. Most popular ranges are listed on the module labels. See www.api-usa.com or contact factory for special ranges.

1. Set the **OUTPUT SELECT** slide switch "A" to current (I) or voltage (V) depending on output type.
2. From the range table, find the rotary switch combination that matches your input and output ranges.
3. Set the three rotary switches B, D, and E to the values found in the table that match your input and output ranges.
4. Set the **INPUT SELECT** slide switch "C" to current (I) or voltage (V) depending on input type.
5. The Zero, Span and Test Range potentiometers can now be adjusted for the desired output range.

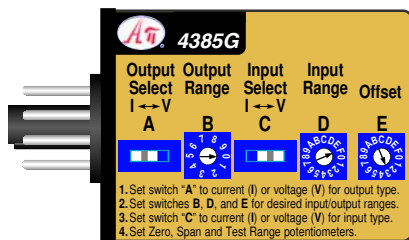

The input selector switch determines the input impedance for the module, typically 50 Ω for current inputs and 1 MΩ or greater for voltage inputs. Depending on the rotary switch settings, the input is filtered, either amplified or attenuated as required, then passed through an optical isolation circuit to the output stage.

API maintains a constant effort to upgrade and improve its products. Specifications are subject to change without notice. Consult factory for your specific requirements.

CALIBRATION

Input and output ranges are pre-configured at the factory as specified on your order. Top-mounted, Zero and Span potentiometers can be used should fine-tuning be necessary. Custom ranges may require factory modification.

1. Apply power to the module and allow a minimum 20 minute warm up time.
2. Using an accurate calibration source, provide an input to the module equal to the minimum input required for the application.
3. Using an accurate measurement device for the output, adjust the Zero potentiometer for the exact minimum output desired. The Zero control should only be adjusted when the input signal is at its minimum. This will produce the corresponding minimum output signal. Example: For 4-20 mA output signal, the Zero control will provide adjustment for the 4 mA or low end of the signal.
4. Set the input at maximum, and then adjust the Span pot for the exact maximum output desired. The Span control should only be adjusted when the input signal is at its maximum. This will produce the corresponding maximum output signal. Example: For 4-20 mA output signal, the Span control will provide adjustment for the 20 mA or high end of the signal.
5. Repeat adjustments for maximum accuracy.

TEST BUTTON & TEST RANGE

The Test pushbutton may be set to provide the desired output when depressed. This will drive the device on the output side of the loop (a panel meter, chart recorder, etc.) with a known good signal that can be used as a system diagnostic aid during initial start-up or during troubleshooting. It can be adjusted to vary the output signal from 0 to 100% of the calibrated output range. When released, the output will return to normal.

Turn the multi-turn Test Range potentiometer while holding the Test Switch depressed until the desired output test level is reached.

Example: If you are isolating a 4-20 mA current loop, when the pushbutton is held depressed, the output from the module will be a constant signal between 4 and 20 mA depending on the setting of the Test Range adjustment pot.

OPERATION

GREEN LoopTracker® Input LED – Provides a visual indication that a signal is being sensed by the input circuitry of the module. It also indicates the input signal strength by changing in intensity as the process changes from minimum to maximum. If the LED fails to illuminate, or fails to change in intensity as the process changes, this may indicate a problem with module power or signal input wiring.

RED LoopTracker output LED – Provides a visual indication that the output signal is functioning. It becomes brighter as the input and the corresponding output change from minimum to maximum. For current outputs, the RED LED will only light if the output loop current path is complete. For either current or voltage outputs, failure to illuminate or a failure to change in intensity as the process changes may indicate a problem with the module power or signal output wiring.

		INPUT RANGES												
		0-1 mA	4-20 mA	0-20 mA	0-50 mV	0-100 mV	0-500 mV	0-2 V	0-5 V	1-5 V	±5 V	0-10 V	±10 V	0-20 V
		BDE	BDE	BDE	BDE	BDE	BDE	BDE	BDE	BDE	BDE	BDE	BDE	BDE
O U T P U T R A N G E S	0-1 V	060	09A	050	020	030	000	080	050	09A	0C3	0C0	0D3	0D0
	0-2 V	860	89A	850	820	830	800	880	850	89A	8C3	8C0	8D3	8D0
	1-5 V	660	69A	650	620	630	600	680	650	69A	6C3	6C0	6D3	6D0
	0-5 V	960	99A	950	920	930	900	980	950	99A	9C3	9C0	9D3	9D0
	0-10 V	360	39A	350	320	330	300	380	350	39A	3C3	3C0	3D3	3D0
	±5 V	460	49A	450	420	430	400	480	450	49A	4C3	4C0	4D3	4D0
	±10 V	560	59A	550	520	530	500	580	550	59A	5C3	5C0	5D3	5D0
	4-20 mA	760	79A	750	720	730	700	780	750	79A	7C3	7C0	7D3	7D0
	0-20 mA	360	39A	350	320	330	300	380	350	39A	3C3	3C0	3D3	3D0



1 Delta Park Blvd #12
Brampton, ON L6T 5G1
905-457-6322 or 800-794-5883
www.mod-tronic.com

RANGE SELECTION

Three rotary switches and two slide switches located on the side of the module are used to select input and output ranges. Most popular ranges are listed on the module labels. See www.api-usa.com or contact factory for special ranges.

1. Set the **OUTPUT SELECT** slide switch "A" to current (I) or voltage (V) depending on output type.
2. From the range table, find the rotary switch combination that matches your input and output ranges.
3. Set the three rotary switches B, D, and E to the values found in the table that match your input and output ranges.
4. Set the **INPUT SELECT** slide switch "C" to current (I) or voltage (V) depending on input type.
5. The Zero, Span and Test Range potentiometers can now be adjusted for the desired output range.

The input selector switch determines the input impedance for the module, typically 50 Ω for current inputs and 1 MΩ or greater for voltage inputs.

Depending on the rotary switch settings, the input is filtered, either amplified or attenuated as required, then passed through an optical isolation circuit to the output stage.

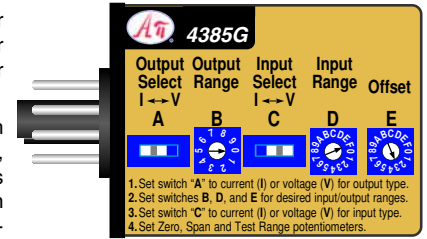

		INPUT RANGES																											
Rotary Switches		0-200 μA	0-1 mA	0-2 mA	0-4 mA	0-8 mA	0-10 mA	0-16 mA	4-20 mA	0-20 mA	10-50 mA	-50-0 mV	0-50 mV	0-100 mV	0-200 mV	0-250 mV	0-400 mV	0-500 mV	0-1 V	0-2 V	0-2.5 V	0-4 V	0-5 V	1-5 V	±5 V	0-10 V	±10 V	0-20 V	20-40 V
		BDE	BDE	BDE	BDE	BDE	BDE	BDE	BDE	BDE	BDE	BDE	BDE	BDE	BDE	BDE	BDE	BDE	BDE	BDE	BDE	BDE	BDE	BDE	BDE	BDE	BDE	BDE	BDE
OUTPUT RANGES	0-1 V	020	060	000	010	080	040	090	09A	050	0CA	02F	020	030	0A0	060	0B0	000	010	080	040	090	050	09A	0C3	0C0	0D3	0D0	0D7
	0-2 V	820	860	800	810	880	840	890	89A	850	8CA	82F	820	830	8A0	860	8B0	800	810	880	840	890	850	89A	8C3	8C0	8D3	8D0	8D7
	0-4 V	120	160	100	110	180	140	190	19A	150	1CA	12F	120	130	1A0	160	1B0	100	110	180	140	190	150	19A	1C3	1C0	1D3	1D0	1D7
	1-5 V	620	660	600	610	680	640	690	69A	650	6CA	62F	620	630	6A0	660	6B0	600	610	680	640	690	650	69A	6C3	6C0	6D3	6D0	6D7
	0-8 V	920	960	900	910	980	940	990	99A	950	9CA	92F	920	930	9A0	960	9B0	900	910	980	940	990	950	99A	9C3	9C0	9D3	9D0	9D7
	2-10 V	720	760	700	710	780	740	790	79A	750	7CA	72F	720	730	7A0	760	7B0	700	710	780	740	790	750	79A	7C3	7C0	7D3	7D0	7D7
	0-10 V	320	360	300	310	380	340	390	39A	350	3CA	32F	320	330	3A0	360	3B0	300	310	380	340	390	350	39A	3C3	3C0	3D3	3D0	3D7
	±5 V	420	460	400	410	480	440	490	49A	450	4CA	42F	420	430	4A0	460	4B0	400	410	480	440	490	450	49A	4C3	4C0	4D3	4D0	4D7
	±10 V	520	560	500	510	580	540	590	59A	550	5CA	52F	520	530	5A0	560	5B0	500	510	580	540	590	550	59A	5C3	5C0	5D3	5D0	5D7
	CURRENT RANGES	0-2 mA	020	060	000	010	080	040	090	09A	050	0CA	02F	020	030	0A0	060	0B0	000	010	080	040	090	050	09A	0C3	0C0	0D3	0D0
2-10 mA		620	660	600	610	680	640	690	69A	650	6CA	62F	620	630	6A0	660	6B0	600	610	680	640	690	650	69A	6C3	6C0	6D3	6D0	6D7
0-10 mA		920	960	900	910	980	940	990	99A	950	9CA	92F	920	930	9A0	960	9B0	900	910	980	940	990	950	99A	9C3	9C0	9D3	9D0	9D7
0-16 mA		220	260	200	210	280	240	290	29A	250	2CA	22F	220	230	2A0	260	2B0	200	210	280	240	290	250	29A	2C3	2C0	2D3	2D0	2D7
4-20 mA		720	760	700	710	780	740	790	79A	750	7CA	72F	720	730	7A0	760	7B0	700	710	780	740	790	750	79A	7C3	7C0	7D3	7D0	7D7
0-20 mA	320	360	300	310	380	340	390	39A	350	3CA	32F	320	330	3A0	360	3B0	300	310	380	340	390	350	39A	3C3	3C0	3D3	3D0	3D7	

API 4385 G RANGE SETTINGS

The tables at right list the settings of the three rotary switches, and can be used to set up special ranges.

For example, if a 1-10 V input is required

Set the Input Select switch to V.

Set switch D to position C = 10 V.

Set switch E to position 1 = +15% offset.

This will create an input range of 1.5 V to 11.5 V.

Use the output zero and span potentiometers to calibrate output to 1-10 V.

For ranges not indicated, please contact factory for assistance or to order modules with custom ranges.

Switch B Output Ranges

Voltage	Current	B
0-1 V	0-2 mA	0
0-2 V	0-4 mA	8
0-4 V	0-8 mA	1
0-5 V	0-10 mA	9
0-8 V	0-16 mA	2
0-10 V	0-20 mA	3
1-5 V	2-10 mA	6
2-10 V	4-20 mA	7
±5 V		4
±10 V		5

Switch D Input Span

Voltage	Current	D
50 mV	200 μA	2
100 mV	400 μA	3
200 mV	800 μA	A
250 mV	1 mA	6
400 mV	1.6 mA	B
500 mV	2 mA	0
1 V	4 mA	1
2 V	8 mA	8
2.5 V	10 mA	4
4 V	16 mA	9
5 V	20 mA	5
10 V	40 mA*	C
20 V		D

* Maximum allowable offset is ±75% for 40 mA range.

Switch "E" Input Offset

% of Input Span	E
+100%	7
+90%	6
+75%	5
+60%	4
+45%	3
+30%	2
+15%	1
0%	0, 8
-15%	9
-30%	A
-45%	B
-60%	C
-75%	D
-90%	E
-100%	F



FREE APPLICATION ASSISTANCE

Call  Customer Service

800-794-5883

MOD-TRONIC
INSTRUMENTS LIMITED

1 Delta Park Blvd #12
Brampton, ON L6T 5G1
905-457-6322 or 800-794-5883
www.mod-tronic.com



What is a Ground Loop?

In a process control loop, a ground loop circuit can develop when each device's ground is tied to a different earth potential thereby allowing current to flow between the grounds by way of the process loop (Figure 1).

Ground loops cause problems by adding or subtracting current or voltage from the process loop. This addition and/or subtraction causes the receiving device to be unable to differentiate between the wanted and unwanted signals and thus can't accurately reflect actual process signals.

The probability of multiple grounds and ground loops being established is especially high when new programmable logic controllers (PLCs) or distributed control systems (DCSs) are installed. With so many conditions within a facility referenced to ground, the likelihood of establishing more than one ground point is great. Thus, if an instrumentation system seems to be acting strangely or erratically, and the problem seems to point toward ground loops, the chore of eliminating all unintended ground connections becomes overwhelming.

Keep in mind that eliminating ground loops just isn't feasible for some instruments, such as thermocouples and some analyzers, because they require a ground to obtain accurate measurements. In addition, some instruments must be grounded to ensure personnel safety.

When ground loops can't be eliminated, the solution lies in the use of signal isolators. These devices break the galvanic path (DC continuity) between all grounds while allowing the analog signal to continue throughout the loop. An isolator also can eliminate the electrical noise of AC continuity (common mode voltage).

Signal isolators can use numerous techniques to achieve their function but the best signal isolators usually employ optical isolators (Figure 2). Regardless of the isolation method used, an isolator must provide input, output, and power isolation. If this three-way isolation is not provided, then an additional ground loop can develop between the isolator's power supply and the process input and/or output signal.

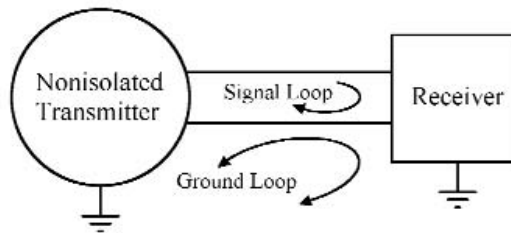

Figure 1. Ground loops may develop with non-isolated transmitters and receivers, resulting in inaccuracy and unreliability.

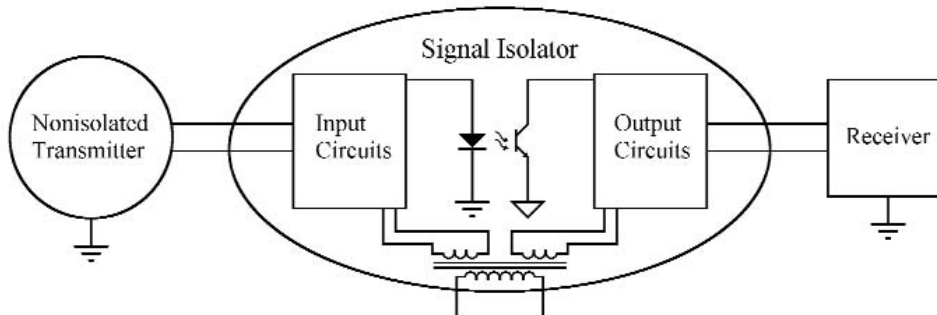
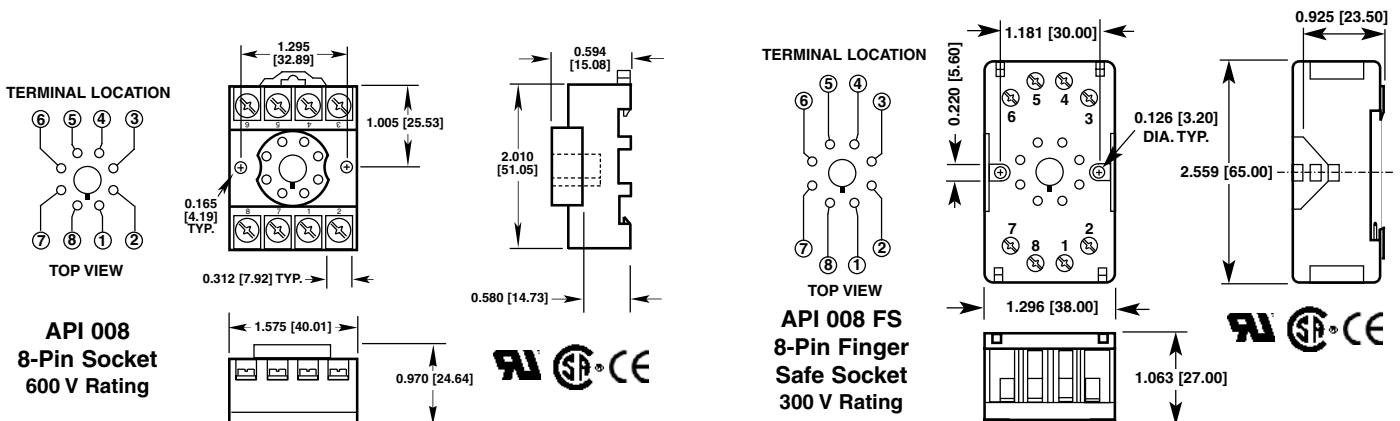

Figure 2. A signal isolator in the process loop blocks ground current to restore signal accuracy and reliability.

API Sockets API 008 and API 008 FS



API maintains a constant effort to upgrade and improve its products. Specifications are subject to change without notice. Consult factory for your specific requirements.