

INSTRUCTIONS FOR THE CT16A2 & CT16A3 SERIES MICROPROCESSOR BASED TEMPERATURE / PROCESS CONTROL



CONTENTS

GETTING STARTED	2
MODEL IDENTIFICATION	3
INSTALLATION	4
WIRING	5
Wiring for 4 to 20mA Transmitter inputs	6
Wiring for Optional Inputs and Outputs	6
FRONT PANEL KEY FUNCTIONS	8
SECURITY LEVEL SELECTION	9
NOTATION CONVENTIONS FOR THE MENUS	10
THE HOME DISPLAY	11
Programming and Operation for Ramp / Soak feature (CT16A3 only) ...	11
Theory of Operation	11
Program Setup	12
Ramp / Soak Operation	13
AUTO / MANUAL OPERATION (CT16A3 ONLY)	14
Operation of Self Tune Function	15
Theory of Operation	15
Program Setup and Operation	15
OPERATION AND PROGRAMMING OF OPTIONS	16
MENU SELECTIONS	18
PRIMARY MENU	18
SECONDARY MENU	19
SECURE MENU	26
ALARM TYPE AND ACTION	31
ERROR MESSAGES	34-36
SPECIFICATIONS	37
DIMENSIONS	40

GETTING STARTED

1. Install the control as described on page 4.
2. Wire your control following the instructions on page 5. If you are using a two-wire transmitter as an input, see the drawing and instructions on page 6. Option wiring instructions are on Page 7. Option descriptions and specific instructions start on page 16.
3. Most controls do not need many (if any) program changes to work on your process. For best results when programming changes are necessary, make all the necessary changes in the Secure Menu (page 26) before making changes to the Secondary Menu (page 19). If error messages occur, check the Error Messages on page 34-36 for help.

Take the example of a Model CT16A3010 that comes from the factory

© 2000, Minco Products, Inc. All rights reserved. Portions used by permission. No portion may be copied without the express written consent of Minco Products.

programmed for type J thermocouples. Suppose for this example you wish to change the input to a 100 ohm Platinum RTD and limit the set point range between 0° and 300° C.

First, enter the Secure menu as instructed on page 26. Press the INDEX key until the display shows *InP* and press the DOWN ARROW until the display shows **P385**. Don't forget to press the ENTER key to retain your setting.

Next, press the INDEX key to display *Unit*. Press the DOWN ARROW until the display shows **℄**. Press ENTER.

Next, press the INDEX key until *SPL* is displayed (pass the *dPt* and *InPt* selections). Press the UP ARROW until the display shows **0**. Press ENTER.

Finally, press INDEX key to display *SPH*. Press the DOWN ARROW until the display shows **300**. Press ENTER.

The necessary program changes are now complete. After 30 seconds the display will switch back to the temperature reading. If you want to return faster, press the UP ARROW and ENTER keys (at the same time) and then press the DOWN ARROW and INDEX keys (again at the same time). This will 'back out' of the menu and immediately display the temperature reading.

If you want to use Self Tune®, Auto/Manual, or the Ramp/Soak Programmer features, see the special sections on these items. Page numbers for these are in the Contents section on the previous page.

MODEL IDENTIFICATION

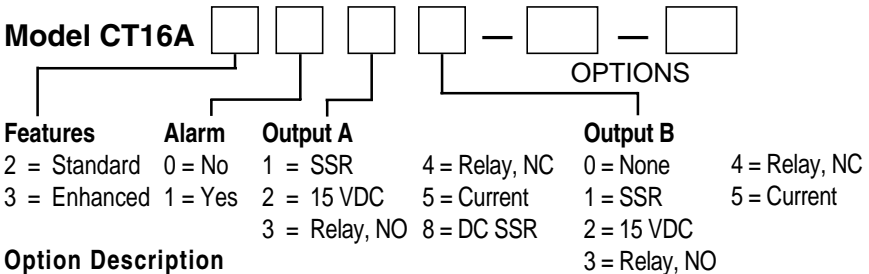

- Option Description**
- 934* Analog Retransmission of Process Variable or Set Variable, 0 to 20 mAdc, scalable (may be programmed for 1 to 5mA, 4 to 20 mA, etc.).
 - 936* Analog Retransmission of Process Variable or Set Variable, 0 to 10 Vdc, scalable.
 - 948 4-Stage Set Point. One of four pre-set set point values can be implemented via contact closure.
 - 992* RS-485 Serial Communications. Allows remote computer to read and write all control parameters.
 - 993* RS-232 Serial Communications. Allows remote computer to read and write all control parameters.

* These options may not be combined with each other. Option 948 may be combined with only one of options 934 or 936.

INSTALLATION

Mount the instrument in a location that will not be subject to excessive temperature, shock, or vibration. All models are designed for mounting in an enclosed panel.

Select the position desired for the instrument on the panel. If more than one instrument is required, maintain the minimum of spacing requirements as shown on the drawing below. Closer spacing will structurally weaken the panel, and invalidate the IP66, UL type 4 rating of the panel.

Prepare the panel by cutting and deburring the required opening.

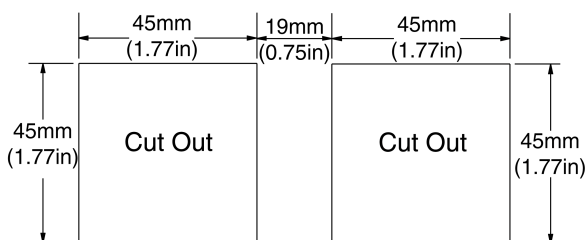

All Tolerances are $-0.00 +0.60\text{mm}$ ($-0.000 +0.020$ in.)

From the front of the panel, slide the housing through the cut out. The housing gasket should be against the housing flange before installing.

From the rear of the panel slide the mounting collar over the housing. Hold the housing with one hand and using the other hand, push the collar evenly against the panel until the spring loops are slightly compressed. The ratchets will hold the mounting collar and housing in place.

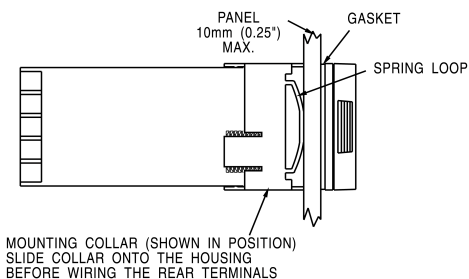

CAUTION: It is not necessary to remove the instrument chassis from the housing for installation. If the instrument chassis is removed from the housing, you must follow industry standard practice for control and protection against Electro-Static Discharge (ESD). Failure to exercise good ESD practices may cause damage to the instrument.



WIRING



Do not run RTD, thermocouple, or other class 2 wiring in the same conduit as power leads. Use only the type of thermocouple or RTD probe for which the control has been programmed. Maintain separation between wiring of sensor, optional inputs and outputs and other wiring. See the "Secure Menu" for input selection.

For thermocouple input always use extension leads of the same type designated for your thermocouple.

For supply connections use No. 16 AWG or larger wires rated for at least 75°C. Use copper conductors only. All line voltage output circuits must have a common disconnect and be connected to the same pole of the disconnect.

Input wiring for thermocouple, current, and RTD; and output wiring for current and 15 VDC is rated CLASS 2.

Control wiring is as shown (view is from rear of instrument showing wiring terminals).

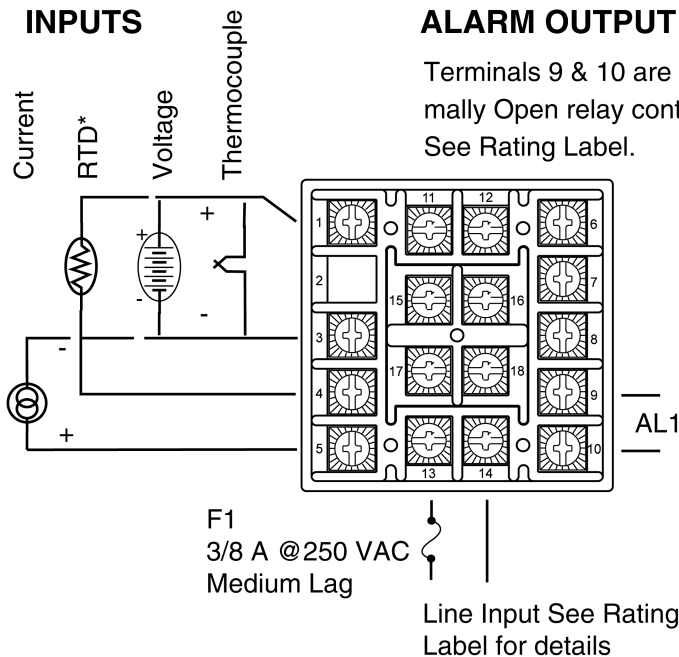

- * For 2-wire 1000 Ω RTD use terminals 1 & 3.
- For 2-wire 100 Ω RTD use terminals 1 & 3, and place a jumper wire between terminals 3 & 4.

OUTPUTS

(Rear View showing center block of wiring terminals.)

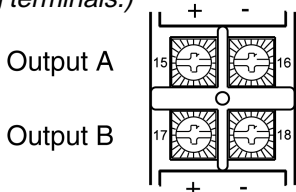

For relay or SSR type outputs, 15 & 16, and 17 & 18 are Normally Open. See Rating Label for details.

For Current or Pulsed DC outputs, 15 & 17 are positive, 16 & 18 are negative.

Note: Factory default assigns Output A to Set Point 1 and Output B to Set Point 2. If necessary, these relationships may be reversed. See **SP 10** in the Secure Menu.

Wiring for 4 to 20mA Transmitter inputs

Wire power and outputs as shown above. Two-wire transmitters wire as shown below. View is of instrument as seen from the rear to show wiring terminals.

For three- or four-wire transmitters follow the wiring instructions provided with your transmitter.



CAUTION: DO NOT WIRE THE 24 VOLT POWER SUPPLY ACROSS THE INPUT OF THE CONTROL. DAMAGE TO THE CONTROL INPUT CIRCUITRY WILL RESULT.

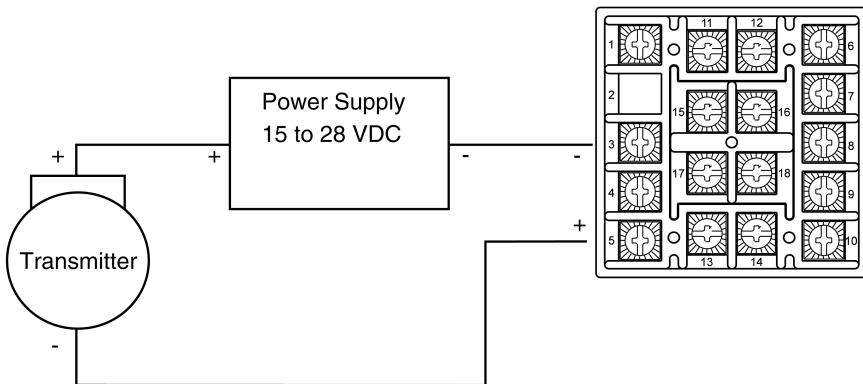

Wiring for Optional Inputs and Outputs

Options are described on Page 3. Detailed option programming and operation starts on Page 16.

Wire power and outputs as shown on pages 5 and 6. Wiring for options is shown opposite. All wiring shown below is Class 2. Shielded twisted pair is required for Option 992. Options 924, 926, and 928 share a common ground with input.



CAUTION: DO NOT RUN SIGNAL WIRING IN THE SAME CONDUIT OR CHASE AS THE POWER WIRING. ERRATIC OPERATION OR DAMAGE TO THE CONTROL CIRCUITRY WILL RESULT.

SWITCH CONTACTS FOR OPTION 948 MUST BE ISOLATED AND CAN NOT SHARE WIRING WITH OTHER CONTROLS.

OPTION / TERMINALS	11	12	6	7	8
934 PV/SV Retransmission, Current (e.g. 4 to 20 mA)	+	-	na	na	na
936 PV/SV Retransmission, Voltage (e.g. 0 to 10 V)	+	-	na	na	na
924 Remote Set Point, Voltage (e.g. 0 to 10 V)	+	-	na	na	na
926 Remote Set Point, Current (e.g. 4 to 20 mA)	+	-	na	na	na
928 Remote Set Point, Resistance (e.g. 0 to 10,000Ω)	CCW	Wiper	na	na	na
948 4-Stage Set Point Selection	na	na	Signal Ground	A	B
992 RS-485 Serial Communications	B	A	na	na	na
993 RS-232 Serial Communications	Data In	Data Out	Signal Ground	na	na

948 Truth Table

A to Gnd.	B to Gnd.	SP
OPEN	OPEN	1SP1
CLOSED	OPEN	2SP1
OPEN	CLOSED	3SP1
CLOSED	CLOSED	4SP1

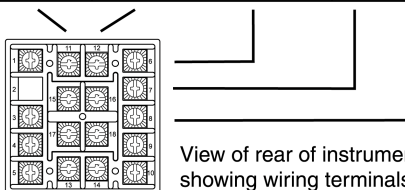

View of rear of instrument showing wiring terminals.

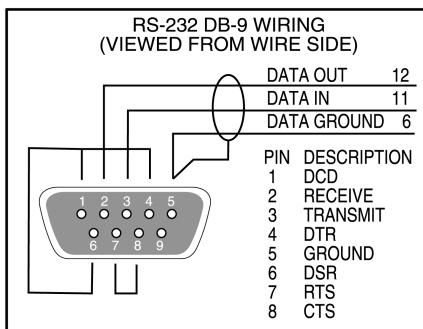
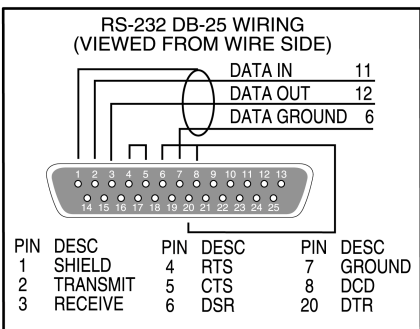
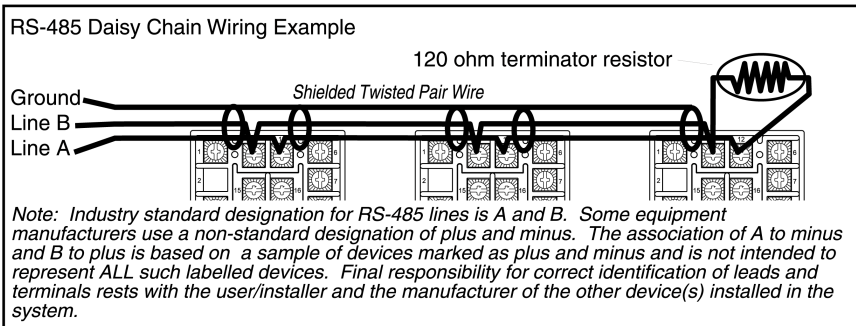



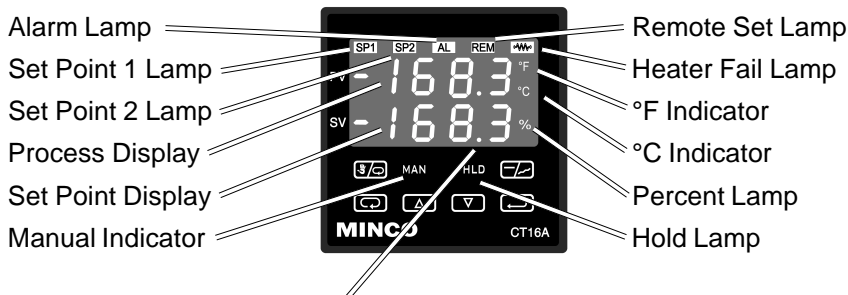









FRONT PANEL KEY FUNCTIONS





The decimal point flashes when Self Tune is operating.

Keys are illuminated when pressed. Key functions are as follows:

-  **INDEX:** Menu Navigation. Pressing the  INDEX key advances the display to the next menu item. May also be used in conjunction with other keys as noted below.
-  **UP ARROW:** Increments a value, changes a menu item, or selects the item to ON. The maximum value obtainable is 9999 regardless of decimal point placement.
-  **DOWN ARROW:** Decrements a value, changes a menu item, or selects the item to OFF. The minimum value obtainable is -1999 regardless of decimal point placement.
-  **ENTER:** Pressing  ENTER stores the value or the item changed. If not pressed, the previously stored value or item will be retained. The display will flash once when  ENTER is pressed.
-  **AUTO/MANUAL (CT16A3):** This key toggles the control output between Automatic mode and Manual mode. Press and hold key for three seconds to activate. See section on AUTO/MANUAL operation on Page 14.
-  **RUN/HOLD (CT16A3):** This key toggles the Ramp/Soak program functions between Run mode (program runs as set up), and Hold mode (program functions are suspended). Press and hold key for three seconds to activate. See section on Ramp/Soak (Page 11) for further details.
-  **UP ARROW & ENTER:** Menu Access. Pressing these keys simultaneously brings up the secondary menu starting at the alarm, tune, or cycle item (depending on programming). Pressing these keys for 5 seconds will bring up the secure menu.
-  **INDEX & DOWN ARROW:** Menu navigation. Pressing these keys simultaneously will allow backing up one menu item, or if at the first menu item they will cause the display to return to the primary menu.
-  **INDEX & DOWN ARROW:** Alarm Reset. If an alarm condition has occurred, press and hold these keys for three seconds to reset the

alarm. Note that the alarm condition will not reset if the alarm condition still exists.

  **INDEX & ENTER:** 'Global Reset'. Pressing these keys simultaneously and holding them for 5 seconds forces a 'warm boot', restarting the control (similar to turning power off and on). 'Global Reset' will allow recovery from errors and reset the following menu items:

AL IH: Alarm inhibit





OPEN INP: Input error message

bad INP: Input error message



CHEC CAL: Check calibration error



Correct the problems associated with the above conditions before using these reset keys. More than one error could be present. Caution is advised since several items are reset at one time.

While in the **Primary** or **Secondary Menu**, if no key is pressed for a period of 30 seconds, the display will return to the HOME position displaying the temperature value. While in the **Secure Menu**, if no key is pressed for a period of 60 seconds, the display will return to the HOME position displaying the temperature value. Outputs are disabled (turned off) when the **Secure Menu** is active.

NOTE: To move to the **Primary Menu** quickly from any other menu, press the   **UP ARROW & ENTER** keys followed by pressing the   **INDEX & DOWN ARROW** keys.

SECURITY LEVEL SELECTION

Four levels of security are provided. The display shows the current security level. To change security levels change the password value using the  **UP ARROW** and  **DOWN ARROW** keys and press the  **ENTER** key. Refer to the password table (following) for the correct value to enter for the security level desired. The **SEC** menu item security level may be viewed or changed at any time regardless of the present security level.

To set the access level to, for example, **2**, at the **SEC** menu item press the  **UP ARROW** key until the upper display shows the password for level **2** access, **1 0 1**. Press the  **ENTER** key. The display will blink and return with the level value, **2**, in the upper display.

The password values shown in the table cannot be altered, so retain a copy of these pages for future reference. This is the only reference made to password values in this instruction book.

PASSWORD TABLE

Security Level Menu	Level Status	Displayed Value When Viewed	Password Value To Enter
Primary Secondary Secure	Locked Locked Locked	<i>1</i>	<i>110</i>
Primary Secondary Secure	Unlocked Locked Locked	<i>2</i>	<i>101</i>
Primary Secondary Secure	Unlocked Unlocked Locked	<i>3</i>	<i>011</i>
Primary Secondary Secure	Unlocked Unlocked Unlocked	<i>4</i>	<i>111</i>

NOTATION CONVENTIONS FOR THE MENUS

Because of the number of features available in this control, information is included that may not apply to your specific control. All usable features are included in this book, but may not be used in your process. To increase clarity the following conventions are used:

1. Certain features, menu items, and functions shown in this book may or may not appear on your control, depending on other menu item selections. At various places in the menus there are notes identifying menu items that "control" or "direct" other menu items. If you are looking for a particular menu item and can't find it, check the menu item that is its "control" for proper setting.
2. The "#" symbol is used in two ways. It is used inside a group of characters to indicate which set point function (SP1 or SP2) is being affected. It is also used before a group of characters of a menu item to indicate that there may be more than one selection or value for that menu item. This is used for certain repeated items such as in the Ramp/Soak Program section.
3. *Features that apply only to Options will be printed in Italics.* Features that apply only to the CT16A3 Series will be notated in Roman type.

THE HOME DISPLAY

The home display is the normal display while the control is operating. If no errors or functions are active, the HOME display will indicate the Process Variable (the temperature, pressure, flow, RH, etc., that is being measured) on the top display and the Set Variable (Set Point 1) on the bottom.

Items that can change the HOME display are the Auto/Manual function, the Run/Hold function, the **Prog** function, the **Pct0** function, and any error message. Description of these special displays follows.

If the **AM** Auto/Manual key is pressed, the Manual indicator lights, and the home display is changed. The upper display continues to show the Process Variable (PV), but the lower display changes to show the percentage of output in tenths of a percent to 99.9% (0.0 to 99.9), or 100 if 100%. The display digit to the right of the number shows a flashing letter **a** to indicate that the value displayed is no longer the SV, but percent output. The **SP2** percent output is indicated by the use of an overline on the letter **a**. Access to the **SP2** value is made by the **INDEX** key. See Auto/Manual Operation on Page 14 for further information.

If **Prog** is turned **On**, the HOME display changes the SV display from **SP 1** to the Present Set Variable as calculated by the Ramp/Soak Programmer function. See Programming and Operation for Ramp/Soak Feature below for more information.

If **Pct0** (Secondary Menu) is turned **On**, the lower display changes to show the active percentage of output as required to maintain **SP 1**. The display is similar to the Auto/Manual display above, except that the percent indicators (**a**, **a**) do not flash, and the output is displayed in whole percentages of output, not in tenths of a percent. If the control has both **SP 1** and **SP2**, the lower display will alternate between the **SP 1** percent output and the **SP2** percent output.

Error messages are listed on Pages 34-36.

Programming and Operation for Ramp / Soak Feature (CT16A3 only)

The ramp / soak feature offers a great deal of flexibility by allowing changes in the set point to be made over a predetermined period of time. Dwell times can be programmed, and the alarm output relay can be programmed to open or close during any of the segments.

Theory of Operation

The CT16A3 Series controls offer a very simple approach to programming a ramp. Rather than requiring the operator to calculate an approach rate

(usually in degrees per minute), the CT16A3 does the calculation internally. Thus, the operator only needs to program the target set point and the time desired to reach that point. When the ramp segment is executed by the control, it calculates the ramp required to move the process from the starting value (current PV) to the desired value (programmed SP) in the time allowed.

Soaks (or dwells) are ramp segments where the target set point is the same as the beginning process value. This allows for multistage ramps without wasting intermediate soak steps. Care must be taken, however, that the process does actually reach the soak value before the soak time starts. If not, the next segment will calculate a slope from the starting PV to the target SP. Depending on your process requirements, this difference may be important. Make sure to test any program for desired results before running production material.

Do not operate Self Tune while a ramp function is operating. The ramp function will prevent the Self Tune from operating properly. Make sure that all tuning is set up before operating Ramp / Soak.

Program Setup

All of the programming for the Ramp / Soak function is done in the Secondary Menu. You may wish to work out your program on paper before going into the programmer menu sequence.

In the Secondary Menu  INDEX to *Prog* and make sure that *Prog* is set to *OFF*.



 INDEX to *PSet* and turn *On*. Press  ENTER.

Skip the *StAt* setting (this is discussed later) and press  INDEX to *t t*.

The following items repeat in the following order: *t t*, *ISP*, *IR I* (if *RL I* in the Secure Menu is programmed set to *ENt*), *2t t*, *2SP*, *2R I*, . . . , *16t t*, *16SP*, *16R I*. To avoid repetition each item will only be described once.

Set *t t* to the amount of time you want for the first ramp. This value is in time units (determined by the *tBAS* menu item) from *0* to *9999*. Press  ENTER.

Set *ISP* to the target value desired for the first ramp. This value is in actual units just like *SP I*. If the control is programmed for temperature, then the SP displays are in temperature. If the control is programmed for some other engineering unit, the SP is set in that unit.

Press  INDEX to continue. If Alarm 1 is programmed as an event ($AL\ 1 = EUnt$), then $IR\ 1$ will appear. If you wish the Alarm 1 contact to function for this segment, set $IR\ 1$ for On . If not, set for OFF . Press  ENTER. When $IR\ 1$ is set to On , the Alarm 1 function will be active for the entire period set in It , above.



Complete setting the segment times ($2t \dots 16t$), segment set points ($2SP \dots 16SP$), and event alarms ($2A\ 1 \dots 16A\ 1$) to On or OFF .

For unneeded or unused segments set the segment times ($2t \dots 16t$) to 0 , and set the segment set points ($2SP \dots 16SP$) to the same value as the last active set point. A segment alarm may be set to indicate "end of run" at the segment number you select.

The last menu item for the ramp / soak function is $PEnd$. $PEnd$ determines what the control does when the program has ended. You may choose to have the program repeat ($Loop$), $Hold$ the last set point ($16SP$), revert to the local $SP\ 1$, or turn the outputs off (OFF).



It is important to remember that if you want the program to repeat, you must allow the process to return to the same condition that existed when the program first started. Remember that the ramp function calculates the slope by drawing a line from the beginning PV to the ramp target set point. If the PV at the end of the program is different than the PV at the initial start, the ramp will calculate differently.

Ramp / Soak Operation

When you wish to start the program, enter the Secondary Menu and set the $Prog$ menu item to On . Return to the HOME position by waiting for the display to time out or by pressing the  UP ARROW & ENTER keys and then the  DOWN ARROW & INDEX keys.

The home display will read as it normally does. The HOLD indicator by the RUN / HOLD key will be lit. To start the program press the  RUN / HOLD key for three seconds. The HOLD indicator will go out, and the program will start.

To suspend the program at any time, press the  RUN / HOLD key. Press the key again to resume.

Pressing the  AUTO / MANUAL key will also suspend the program operation. The difference is that  AUTO / MANUAL also puts the control into manual mode. See Auto / Manual Operation on page 14.

The function of the Primary Menu will change depending on the setting of the **SEtPt** menu item in the Secondary Menu. If **SEtPt** is **OFF** then the Primary Menu is not changed.

If the **SEtPt** menu item is set to **On**, then the Primary Menu has three additional information items added before **SP I** appears. The first **INDEX** item displays the time remaining in the current segment in the top display (#####), and the message **t r**, in the lower display. The next **INDEX** item displays the total time for the active segment in the upper display (#####) and the message **##t r (It ... t t r)**, in the lower display. The third **INDEX** item displays the segment set value (#####) in the top display, and the message **##SP (ISP... tSP)** in the lower display. The next **INDEX** press resumes the normal Primary Menu

AUTO / MANUAL OPERATION (CT16A3 ONLY)

The AUTO / MANUAL function allows you to manually adjust the output of the control. This is normally used during process setup or start up. It can also be used for troubleshooting. To switch from AUTO to MANUAL press the **MAN** AUTO / MANUAL key and hold for three seconds. The MANual indicator will light and the lower display will change from normal to showing the actual output in percent. The value will be the actual percentage of output that was active when the key was pressed. This is usually known as "bumpless transfer".

If you wish to change the output while in manual, press the **UP** UP ARROW or **DN** DOWN ARROW keys to change the value, and press **ENT** ENTER to retain it. It is important to remember that the value of the display can be read as 0 to 100% of the full control output, or 0 to 100% of the range between **S tOL** and **S tOH** or **S2OL** and **S2OH**. If **APCt** is set for **rEARL**, a reading of 50% in MANUAL represents 10 mA. If **APCt** is set for **Adj**, then 50% in MANUAL will represent the mid point in output between **S tOL** and **S tOH**. (Assuming **S tOL** is **20** and **S tOH** is **100** [4 to 20 mA], 50% will represent 12 mA.)

To return to AUTOMATIC control, press the **MAN** AUTO / MANUAL key again. The MANual indicator will go out, and the set point will take over. However, if you want bumpless transfer back to AUTO, slowly change the percentage of output until the process variable matches (or at least is close) to the set point. The further away the PV is from the set point, the greater the "bump" or upset there will be in the output.

Operation of Self Tune Function

Self Tune allows automatic selection of the necessary parameters to achieve best control operation from your CT16A2 & CT16A3 Series control. If you are using the control output as a simple on-off function (**Out 1** set for **OnOff**), none of the following will apply.

Theory of Operation

The Self Tune function calculates the **Pb 1**, **rES**, and **rEE** parameters under the **P id tune** selection, and the **Fbnd** and **FrtE** parameters, as shown in the Secondary Menu. These values are determined by measuring the response of the process connected to the control. When Self Tune is started, the control temporarily acts as an on-off control. While in this mode the control measures the overshoot and undershoot of the process, and the period of the process (the time from peak value to the next peak value). These measurements are collected over a period that lasts three periods of overshoot and undershoot. The data collected over this time is then compared and calculated into final PID and Fuzzy Logic values. The effect of Fuzzy Logic on the process is still controlled by the **F int** (fuzzy intensity) setting. If **F int** is **0**, the **Fbnd** and **FrtE** will be calculated, but will have no effect. The calculations for the PID values are the same as used in the standard Ziegler - Nichols equations that have been recognized as standard for decades.

The only modification to the application of the Ziegler - Nichols equations is controlled by the **dFAC** menu item. This menu item controls the amount of rate (derivative) that is applied. A **dFAC** setting of **3** (factory default) or less allows for less damping. A **dFAC** setting of **4** allows for critical damping as set forth in Ziegler - Nichols. A **dFAC** setting of **5** or more allows over damping of the process.

Program Setup and Operation

Do not cool the process or add heat while the tuning is occurring. In the secondary menu set **tune** to **SELF**. Skip **LErn** and check to make sure that **dFAC** is set to the desired value. Back up to **LErn** and set to **YES**. The control will begin the Self Tune function. While the Self Tune function is active, the right hand decimal point on the lower display will blink. When Self Tune is complete, the blinking will stop.

After Self Tune is complete, the **tune** setting automatically switches to **P id**. This allows examination and / or modification of the values calculated. We recommend that you do not change the calculated values unless you have a firm understanding of the parameters involved and their function.

OPERATION AND PROGRAMMING OF OPTIONS

Options 924, 926, 928, Analog Remote Set Point

The analog remote set point allows the control set point to be determined by an outside analog signal. The signal may be 0 to 10 VDC (Option 924), 0 (or 4) to 20 mADC (Option 926), or 0 to 10,000 Ohms (Option 928).

Wire the input as shown on page 7.

To set up the analog remote set point, first determine the scale range that the analog signal will represent. The maximum span is 11,998 degrees or counts. In the Secure Menu set **rSCL** for the scale value that will be represented by the low end of the analog signal (0 Volts, 0 mA, 0 Ohms). Set **rSCH** for the scale value that will be represented by the high end of the analog signal (10 Volts, 20 mA, 10,000 Ohms).

If you require a suppressed scale or input, use the following equations to determine the proper settings for **rSCL** and **rSCH**.

$$K = (\text{Highest desired scale reading} - \text{Lowest desired scale reading}) / (\text{Maximum desired analog signal} - \text{Minimum desired analog signal}).$$
$$rSCH = ((\text{Maximum possible analog signal} - \text{Maximum desired analog signal}) * K) + \text{Highest desired analog reading}.$$
$$rSCL = \text{Lowest desired scale reading} - ((\text{Minimum desired analog signal}) * K).$$

Operation is simple. Make sure that a valid analog signal is available to the control. In the Secondary Menu set the **rSPt** to **On**. The REM indicator on the front of the control will turn on. When the control returns to the HOME position, the displayed SV will be the value supplied from the analog remote signal. If the analog remote signal fails or goes out of range of the **SPL** or **SPH** settings, the control will revert to the internal **SP I** (or **#SP I**), and flash the error message **CHEC rSPt**. If **SPL** or **SPH** are set outside of **rSCL** or **rSCH** then the error will be suppressed, and the control will attempt to work with the remote value.

To clear the error message, change **rSPt** to **OFF**.

Option 934, 936, Isolated Analog Retransmission.

The analog retransmission option allows the Process Variable or the Set Variable to be sent as an analog signal to an external device. The signal may be either 0 to 10 VDC (Option 936) or 0 (or 4) to 20 mADC (Option 934). The output may be changed in the field from one to the other by the toggle switch located on the top printed circuit board.

Wire the output as shown on page 7.

To set up the analog retransmission, first determine the scale range that the analog signal will represent. The maximum scale is 9999°F, 5530°C, or 9999 counts. In the Secondary Menu set **PQL** for the scale value that will be represented by the low end of the analog signal (0 Volts or 0 mA). Set **POH** for the scale value that will be represented by the high end of the analog signal (10 Volts or 20 mA).

If you require a suppressed scale or output, use the following equations to determine the proper settings for **PQL** and **POH**.

$K = (\text{Highest desired scale reading} - \text{Lowest desired scale reading}) /$
 $(\text{Maximum desired analog signal} - \text{Minimum desired analog signal}).$

$POH = ((\text{Maximum possible analog output} - \text{Maximum desired analog signal}) * K) + \text{Highest desired analog reading}.$

$PQL = \text{Lowest desired scale reading} - ((\text{Minimum desired analog output}) * K).$

Next select whether you want the retransmission signal to follow the Process Variable or the Set Variable. Usually the Process Variable is sent to recorders or other data acquisition devices. Usually the Set Variable is sent to other controls to be used as an analog remote set point. If you want the analog retransmission signal to follow the PV, in the Secondary Menu set **POSr** to **inP**. If you want the analog retransmission signal to follow the SV, set **POSr** to **SPt**.

Operation is automatic. There are no further programming steps required.

Option 948, 4-Stage Set Point.

The 4-stage set point option allows four different values to be used for **SP t** and all of the values associated with the **tunE** menu items. The control will switch to a given stage when an external contact or contacts are made or opened across the appropriate terminals at the rear of the control (**SPSA**, Set Point Switch Action, set for remote, **rE**), or when the stage is selected from the Secondary Menu, **SP** (when **SPSA** is set for **int**). When the state of a contact changes (or the stage number is changed in the Secondary Menu), the values in use are stored and the previously stored values for the new stage are used.

Wire the input as shown on page 7.

Usually the control is configured for external switching of the stages. In this case, the operation is usually automatic, selected by the external switches driven by the machine logic. If it is necessary to program the stages in advance, you may select the stage to modify with the **SP** menu item. When **SP** is changed while the **SPSA** is set for **rE**, the selected stage is displayed for modification, but only used when the appropriate contact is made.

Option 992, 993, Serial Communication.

The serial communications options allow the control to be written to and read from a remote computer or other similar digital device. Communication is allowed either through a RS-485 (Option 992) port, or a RS-232 (Option 993) port.

Wire the communication lines as shown on Page 7. Wiring for the RS-485 is run from control to control in a daisy chain fashion with a termination resistor (120 ohms) across the transmit and receive terminals of the last control in the chain.

Select the control address and communication baud rate with the **Addr** and **BAUD** menu items in the Secure Menu.

NOTE: THE BAUD RATE AND ADDRESS MENU ITEMS WILL TAKE EFFECT ON THE NEXT POWER UP OF THE CONTROL. BE SURE TO POWER CYCLE THE CONTROL BEFORE USING THE NEW BAUD RATE AND ADDRESS.

In operation, you have the option of preventing a write command from the host computer. To prevent the host from writing to the control change the **LOrE** menu item in the Secondary Menu to **LOC**. To allow the host to write commands to the control set **LOrE** to **rE**. (The host does have the ability to change the **LOrE** state, but it is not automatic.)

If your system depends on constant reading or writing to and from the host, you may wish to set the No Activity Timer (**nAt**) to monitor the addressing of the control. When the **LOrE** is set to **rE** and the **nAt** is set to any value other than **OFF**, the control will expect to be addressed on a regular basis. If the control is not addressed in the time set by the value of **nAt**, then the control will display the error message **CHEC LOrE**. To clear the message set **LOrE** to **LOC**.

MENU SELECTIONS

PRIMARY MENU

Press **[>]** **INDEX** to advance to the next menu item. Press **[▲]** **UP ARROW** or **[▼]** **DOWN ARROW** to change the value in the display. Press **[↵]** **ENTER** to retain the value. If **StAt**, (Secondary Menu [CT16A3]), is **On**, the three program status menu items shown on Page 14 will precede the following.

#SP 1 (Option 948, 4-Stage Set Point) or

SP 1 Set Point 1 Adjust, Control Point 1.

SP2 Set Point 2 Adjust (if equipped), Control Point 2.

SECONDARY MENU

Hold **▲** **▶** **UP ARROW** & **ENTER**. Press **◀** **INDEX** to advance to the next menu item. Press **▲** **UP ARROW** or **▼** **DOWN ARROW** to change the value in the display. Press **▶** **ENTER** to retain the value.

ALo Alarm 1 Low: The Low Alarm point is usually set below the Set Point. May not appear depending on **AL I** setting in Secure Menu.

ALH Alarm 1 High: The High Alarm Point is usually set above the Set Point. May not appear depending on **AL I** setting in Secure Menu.

Out I Output selection: Select **OnOff**, **ItP**, **IPUL**, or **Prop**.

OnOff A setting of **OnOff** allows the control to operate in simple on/off mode. This setting forces the control to turn off at set point, and on at the set point plus the differential (**SP Id**). When selected, the **Out I OnOff** menu item is followed by **#### SP Id**, and the **tunE**, **Pb**, **rES**, **QFS**, **rLE**, and **ArUP** selections in the Secondary menu and the **S IDL** and **S IDH** selections in the Secure menu are suppressed.

SP Id Set Point On-Off Differential (hysteresis). Set for the amount of difference between the turn off point and the turn on point. Select **I** to **9999** (direct acting), or **- I** to **-9999** (reverse acting). This value will be negative for reverse acting set points, and positive for direct acting outputs. The following drawing shows output behavior for reverse and direct action. For reverse action note how the output decreases as the input process variable increases, e.g. heat power goes to zero as the temperature increases to set point.

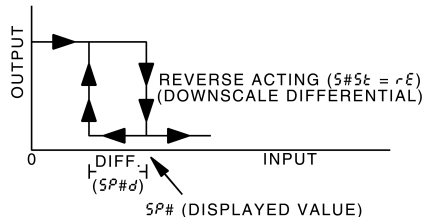
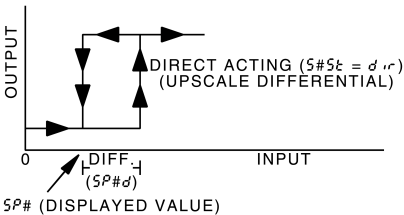

##tP Time Proportioning Cycle Time. Select **ItP** to **80tP**.

ItP A setting of **ItP** is recommended for solid state outputs (SSR or 15VDC).

2tP to 80tP Time Proportioning Control is adjustable in 1 second steps. Recommended for mechanical outputs (relays, solenoids, etc.). For best con-

tact life, a time should be selected as long as possible without causing the process to wander.

#PUL Pulsed Time Proportioning Output: Select **iPUL** to **7PUL**. **iPUL** = Linear and **7PUL** = most nonlinear. Changes output linearity for use in cooling applications or for extremely fast response processes. At the center of the proportional band, a pulse value of 1 provides an output of one second on and one second off (50% output). A pulse value of 2 provides an output of one second on and two seconds off (33% output). Output at center of band equals one second on, $2^{(\text{pulse value}-1)}$ seconds off.

ProP For Current (Code 5) outputs only.

The following menu items apply only if your control is equipped with a second set point (last digit of model number is not zero). If your control does not have a second set point, jump to the **εεε** menu on the next page.

Out2 Output selection: Select **OnOff**, **2tP**, **2PUL**, or **ProP**.

OnOff A setting of **OnOff** allows the control to operate in simple on/off mode. This setting forces the control to turn off at set point, and on at the set point plus the differential (**SP2d**). When selected, the **Out2 OnOff** menu item is followed by ##### **SP2d**, and the **Pb2** selection in the Secondary menu and the **S2OL** and **S2OH** selections in the Secure menu are suppressed.

SP2d Set Point On-Off Differential (hysteresis). Select **!** to **9999** (direct acting), or **- ! εε -9999** (reverse acting). See **SP Id** on the previous page.

##tP Time Proportioning Cycle Time. Select **!tP** to **80tP**.

!tP A setting of **!tP** is recommended for solid state outputs (SSR or 15VDC).

2tP εε 80tP Time Proportioning Control is adjustable in 1 second steps. Recommended for mechanical outputs (relays, solenoids, etc.). For best contact life, a time should be selected as long as possible without causing the process to wander.

#PUL Pulsed Time Proportioning Output: Select **iPUL** to **7PUL**. **iPUL** = Linear and **7PUL** = most nonlinear. Changes output linearity for use in cooling applications or for extremely fast response processes. At the center of the proportional band, a pulse value of 1 provides an output of one second on

and one second off (50% output). A pulse value of 2 provides an output of one second on and two seconds off (33% output). Output at center of band equals one second on, $2^{(\text{pulse value}-1)}$ seconds off.

ProP For Current (Code 5) outputs only.

SP (Option 948, 4-Stage Set Point) Active Set Point Stage. Select **1SP I**, **2SP I**, **3SP I**, **4SP I**. (See Page 17 for more detail.)

1SP I Set Menu Items to display Stage 1 for view and change access. If **SPSA** is set for **Int**, **1SP I** is made active.

2SP I Set Menu Items to display Stage 2 for view and change access. If **SPSA** is set for **Int**, **2SP I** is made active.

3SP I Set Menu Items to display Stage 3 for view and change access. If **SPSA** is set for **Int**, **3SP I** is made active.

4SP I Set Menu Items to display Stage 4 for view and change access. If **SPSA** is set for **Int**, **4SP I** is made active.

#SP I (Option 948, 4-Stage Set Point) Adjust Control Point 1 for Stage selected above.

Note: The menu items for **tunE** (below) are modified when Option 948 is active. Then, the menu items are shortened or shifted right, and preceded with the stage number selected in **SP** above. Each stage has its own set of **tunE** parameters as indicated by **#tun**.

#tun (Option 948, 4-Stage Set Point) or
tunE Tuning Choice: Select **SELF**, **P id**, **SLO**, **nor**, or **FAST**.

SELF The Controller will evaluate the Process and select the PID values to maintain good control. Active for SP1 only.

LErn Select **YES** or **no**

YES Start Learning the Process. After the process has been learned the menu item will revert to **no**.

no Learning will stay in present mode.

dFAC Damping factor, Select **OFF**, **1** to **7**. Sets the ratio of Rate to Reset for the **SELF tunE** mode. **7**= most Rate. Factory set to **3**. For a fast response process the value should be lowered (less Rate). For a slower process the value should be increased (more Rate).

P id Manually adjust the PID values. PID control consists of three basic parameters, Proportional Band (Gain), Reset Time (Integral), and Rate Time (Derivative).

- #Pb 1** (Option 948, 4-Stage Set Point) or
Pb 1 Proportional Band (Bandwidth). Select **1** to **9999** °F, °C, or counts.
- Pb2** Proportional Band (Bandwidth). Select **1** to **9999** °F, °C, or counts. Appears only if control is equipped with second set point and **Out2** is NOT selected as **OnOff**.
- #rES** (Option 948, 4-Stage Set Point) or
rES Automatic Reset Time. Select **OFF**, **0.1** to **99.9** minutes. Select **OFF** to switch to **OFFS**.
- #OFFS** (Option 948, 4-Stage Set Point) or
OFFS Manual Offset Correction Select **OFF**, **0.1** to **99.99** percent. Select **OFF** to switch to **rES**.
- #rtE** (Option 948, 4-Stage Set Point) or
rtE Rate Time. Select **OFF**, **0.01** to **99.99** minutes, Derivative.
- SLO** PID values are preset for a slow response process.
nor PID values are preset for a normal response process.
FAST PID values are preset for a fast response process.
- P_id2** Linkage of PID parameters between SP1 and SP2: Select **On** or **OFF**.
- On** Applies SP1 **rES**, **rtE**, **Fbnd**, and **FrteE** terms to SP2 for heat/cool applications.
OFF SP2 functions without **rES**, **rtE**, **Fbnd** and **FrteE**.
- ArUP** Anti-Reset Windup Feature: Select **On** or **OFF**.
- On** When **ArUP** is **On** the accumulated Reset Offset value will be cleared to 0% when the process input is not within the Proportional Band.
OFF When **ArUP** is **OFF**, the accumulated Reset Offset Value is retained in memory when the process input is not within the Proportional Band.
- ArteE** Approach Rate Time: Select **OFF**, **0.01** to **99.99** minutes. The function defines the amount of Rate applied when the input is outside of the Proportional Band. The **ArteE** time and the **rtE** time are independent and have no effect on each other. To increase damping effect and reduce overshoot set the approach rate time for a value greater than the natural rise time of the process (natural rise time = process value time to set point).
- F_int** Fuzzy Logic Intensity: Select **0** to **100%**. 0% is OFF (disables Fuzzy Logic). The function defines the amount of impact Fuzzy Logic will have on the output.

Fbnd Fuzzy Logic Error Band: Select **0** to **4000** °F, °C, or counts. Sets the bandwidth of the Fuzzy Logic. Set **Fbnd** equal to PID proportional band (**Pb I**) for best results.

FrtE Fuzzy Logic Rate of Change: Select **0.00** to **99.99** counts/second. For best initial setting, find the counts/second change of process value near Set Point 1 with output ON 100%. Multiply this value by 3. Set **FrtE** to this calculated value.

PEA The Peak feature stores the highest input the control has measured since the last reset or Power On. At Power On **PEA** is reset to the present input. To manually reset the value **PEA** must be in the lower display. Press the  **ENTER** key to reset. **PEA** will be reset and display the present input value.

VAL The Valley feature stores the lowest input the Instrument has measured since the last reset or Power On. At Power On **VAL** is reset to the present input. To manually reset the value **VAL** must be in the lower display. Press the  **ENTER** key. **VAL** will be reset and display the present input value.

PctO Percent Output Feature: Select **On** or **OFF**.
On When selected **On**, the HOME lower display will indicate the output of the controller in percent. An "o" will appear in the right hand side of the lower display to indicate percent output for SP1. An "o" will appear on the right hand corner of the lower display to represent percent output for SP2, if the control is so equipped. The display will alternate between these values.

OFF Percent Output display is disabled.

Pro9 Ramp/Soak Feature (CT16A3): Select **On** or **OFF**
On Allows Programmed Ramp/Soak function to be started by the Run/Hold key on the control front panel.

OFF Turns Ramp/Soak function **OFF** and resets program to beginning.

PSEt Programmer function set (CT16A3). Select **On** or **OFF**.
OFF Skip Ramp/Soak Programming. Go to next Secondary Menu Item, InPC on the next page.

On Enable Ramp/Soak Programming.

Stat Programmer Status Display in the Primary Menu when Prog (above) is On (CT16A3): Select **On** or **OFF**.

OFF The Primary Menu operates as normal.

On The Primary Menu is altered to have the following

items inserted before the SP1 menu item:
 ##### *t*, time remaining in active segment
 ##### *##t*, total time in active segment
 ##### *##SP* segment target set point

tbAS Ramp/Soak Time Base (CT16A3). Select *1.5* or *60.5*.
1.5 Ramp/Soak time base is in 1 second increments.
 Program time *t* ... *!6t*, is measured in seconds.
60.5 Ramp/Soak time base is in 60 second increments
 (minutes). Program time *t* ... *!6t*, is measured in
 minutes.

The following items repeat in the following order: *t*, *!SP*, *!R1* (if *!L1* is programmed as *!Unit*), *2t*, *2SP*, *2R1*, ..., *!6t*, *!6SP*, *!6R1*. To avoid repetition each item will only be described once.

t, Segment Time (CT16A3): Select *0* to *9999* units (minutes if *tbAS* is set to *60.5*, seconds if *tbAS* is set to *1.5*).

!SP Segment Set Point (CT16A3): Set to target value desired.

!R1 Segment Alarm 1 Event (CT16A3): Select *On* or *OFF*.
On Alarm 1 is active during segment 1 time (*t*).
OFF Alarm 1 is inactive during segment 1 time (*t*).

PEnd Program End action (CT16A3): Select *Hold* or *GoFF*.
Hold Stay at the Present Set Point (*!SP*).
GoFF Turn Off SP1 and SP2 Outputs at the end of the
 program.
Loop Repeat program starting at *t*.
SP1 Revert to *SP1* value.

inPC Input Correction: Select *-500* to *0* to *500* °F, °C, or counts. This feature allows the input value to be changed to agree with an external reference or to compensate for sensor error. **Note:** *inPC* is reset to zero when the input type is changed, or when decimal position is changed. Factory default is *0*.

Filt Digital Filter: Select *OFF*, *1* to *99*. In some cases the time constant of the sensor, or noise, could cause the display to jump enough to be unreadable. A setting of 2 is usually sufficient filtering (2 represents approximately a 1 second time constant). When the 0.1 degree resolution is selected this should be increased to 4. If this value is set too high, controllability will suffer.

- LPbr** Loop Break Protection: Select **OFF**, **1** to **9999** seconds. If, during operation, the output is minimum (0%) or maximum (100%), and the input moves less than 5°F (3°C) or 5 counts over the time set for **LPbr**, the **LOOP bAd** message will appear. This condition can also be routed to an Alarm Condition if alarms are present and turned On (see **ALbr** in the Secure Menu). The loop break error can be reset by pressing the **ENTER** key when at the **LPbr** menu item. The **INDEX & ENTER** keys may also be used.
- PQL** (Option 934, 936, Analog Retransmission Output) Process Output Low: Select -450°F, -260°C, or -1999 counts to any value less than **POH**.
- POH** (Option 934, 936, Analog Retransmission Output) Process Output High: Select from any value greater than **PQL** to +9999°F, +5530°C, or 9999 counts.
- POSr** (Option 934, 936, Analog Retransmission Output) Process Output Source: Select **InP** or **SPt**.
InP Output follows the Process Variable (input).
SPt Output follows the Set Variable.
- rSPt** (Option 924, 926, 928, Analog Remote Set Point) Remote Set Point: Select **On** or **OFF**.
OFF The control uses the value set for **SP I**.
On The control uses the value set by the analog remote set point signal as established by the Secure Menu items **rSCL** and **rSCH**. If the analog signal fails, the control will display the error message **CHEC rSPt** and revert to the **SP I** local value.
- LQrE** (Option 992, 993, Serial Communications) Local / Remote Status: Select **LOC** or **rE**. Does not affect other instruments on daisy chain.
LOC The host computer is advised that remote write commands will be rejected. Any write commands sent to this control will be rejected. All read commands are accepted.
rE The host computer is allowed to send write commands. If the control is not addressed within the time set in **nAt** (No Activity Timer in the Secure Menu) the **CHEC LorE** error message will be displayed.
- Addr** (Option 992, Serial Communications) Control Address: Set from 1 to 3FF. This number (hexadecimal, base 16) must match the address number used by the host computer. Not settable in this menu. To change this parameter, see **Addr** in the Secure Menu.

SECURE MENU

Hold **[A]** **[↵]** **UP ARROW & ENTER** for 5 Seconds. Press **[↵]** **INDEX** to advance to the next menu item. Press **[A]** **UP ARROW** or **[V]** **DOWN ARROW** to change the value in the display. Press **[↵]** **ENTER** to retain the value.

OUTPUTS ARE DISABLED (TURNED OFF) WHILE CONTROL IS IN SECURE MENU.

SEC Security Code: See the Security Level Selection and the Password Table in this manual, in order to enter the correct password.

inp Input Type: Select one of the following. Refer to the Wiring section for the proper wiring.

J- [C]	Type "J" Thermocouple
[R]	Type "K" Thermocouple
E-	Type "E" Thermocouple
t-	Type "T" Thermocouple
L-	Type "L" Thermocouple
n-	Type "N" Thermocouple
r- [3]	Type "R" Thermocouple
S- [0]	Type "S" Thermocouple
b-	Type "B" Thermocouple
[C]	Type "C" Thermocouple
P392	100 ohm Platinum (NIST 0.00392 $\Omega/\Omega/^\circ\text{C}$)
n [20]	120 ohm Nickel
P385	100 ohm Platinum (IEC/DIN 0.00385 $\Omega/\Omega/^\circ\text{C}$)
[P38]	1000 ohm Platinum (IEC/DIN 0.00385 $\Omega/\Omega/^\circ\text{C}$)
[curr]	DC Current Input 0.0 to 20.0 or 4.0 to 20.0 mA.
[volt]	DC Voltage Input 0.0 to 10.0 or 1.0 to 10.0 volts.
[d FF]	DC Voltage Input -10 to +10 mV.
- - - -	Reserved

OSUP Zero Suppression: Select **On** or **OFF**. Only with Current and Voltage input types.

OFF	The input range will start at 0 (zero) Input.
On	The input range will start at 4.00 mA or 1.00 V.

Unit **F, [C] or nonE.**

F	$^\circ\text{F}$ descriptor is On and temperature inputs will be displayed in actual degrees Fahrenheit.
[C]	$^\circ\text{C}$ descriptor is On and temperature inputs will be displayed in actual degrees Celsius.
nonE	$^\circ\text{F}$ and $^\circ\text{C}$ descriptors will be Off. This is only available with Current and Voltage Inputs.

dPt Decimal Point Positioning: Select **0**, **0.0**, **0.00**, **0.000**, or **.0000**. On temperature type inputs a change here will alter the Process Value, SP1, SP2, ALLo, ALHi, and InPC. For Current and Voltage Inputs all Menu Items related to the Input will be affected.

0 No decimal Point is selected. This is available for all Input Types.

0.0 One decimal place is available for Type J, K, E, T, L, RTD's, Current and Voltage Inputs.

0.00 Two decimal places is only available for Current and Voltage Inputs.

0.000 Three decimal places is only available for Current and Voltage inputs.

.0000 Four decimal places is only available for Current and Voltage inputs.

inPt Input Fault Timer: Select **OFF**, **0.1** to **540.0** minutes. Whenever an Input is out of range (**UFL** or **OFL** displayed), shorted, or open, the timer will start. When the time has elapsed, the controller will revert to the output condition selected by **inPb** below. If **OFF** is selected, the Input Fault Timer will not be recognized (time = infinite).

inPb Input Fail Action (CT16A3): Select **FR IL**, **AUE**, or **PrE**. When the Input is out of range (**UFL** or **OFL** displayed) and the Input timer (**inPt**) time has elapsed, the controller will revert to the selected condition.

FR IL Outputs are disabled (go to 0% output).

AUE The outputs will hold at the last known average percentage of output.

PrE The outputs will maintain preprogrammed percentages of output as specified in **PrE1** and **PrE2**.

PrE1 Preset output for Set Point 1. Select 0 to 100%.

PrE2 Preset output for Set Point 2. Select 0 to 100%.

APCt Manual and PctO display adjustment (CT16A3). Select **rEAL** or **Adj**.

rEAL Manual display will display output 0 to 100% relative to actual range of the output.

Adj Manual display will display output 0 to 100% relative to the **S#OL** and **S#OH** settings.

SEnC Sensor Rate of Change: Select **OFF**, **1** to **4000** °F, °C, or counts per 1 second period. This value is usually set to be slightly greater than the fastest process response expected during a 1 second period,

but measured for at least 2 seconds. If the process is faster than this setting, the **SEnC bAd** error message will appear. The outputs will then be turned off. This function can be used to detect a runaway condition, or speed up detection of an open thermocouple. Use the  **INDEX & ENTER** keys to reset.

SCAL Scale Low: Select **100** to **9999** counts below **SCAH**. The total span between **SCAL** and **SCAH** must be within 11998 counts. Maximum setting range is -1999 to +9999 counts. For Current and Voltage inputs, this will set the low range end. Value not adjustable for Thermocouple and RTD ranges.

SCAH Scale High: Select **100** to **9999** counts above **SCAL**. The total span between **SCAL** and **SCAH** must be within 11998 counts. Maximum setting range is -1999 to +9999 counts. For Current and Voltage inputs, this will set the high range end. Value not adjustable for Thermocouple and RTD ranges.

SPL Set Point Low: Select from the lowest input range value to **SPH** value. This will set the minimum SP1 or SP2 value that can be entered. The value for SP1 or SP2 will not stop moving when this value is reached.

SPH Set Point High: Select from the highest input range value to **SPL** value. This will set the maximum SP1 or SP2 value that can be entered. The value for SP1 or SP2 will not stop moving when this value is reached.

SP10 Set Point 1 Output Select: Select **OutA** or **OutB**.
OutA Set Point 1 is routed through Output A, Set Point 2 (if equipped) is routed through Output B.
OutB Set Point 1 is routed through Output B, Set Point 2 (if equipped) is routed through Output A.

S1St Set Point 1 State: Select **dir** or **rE**.
dir Direct Action. As the input increases the output will increase. Most commonly used in cooling processes.
rE Reverse Action. As the input increases the output will decrease. Most commonly used in heating processes.

If **Out 1** (Page 19) is set for **##tP**, **#PUL**, or **ProP**, then **S10L** and **S10H** appear. If **Out 1** is set for **OnOF**, then skip to **S1rE**.

S10L Set Point Output Low Limit: Select **0** to **100%** but not greater than **S10H**. This item limits the lowest output value. This is useful for adding a bias to the process when needed. Factory set to **0** for



output codes 1,2, 3, 4, and 8. Factory set to **20** for output code 5 (20% output equals 4 mA output).

S IOH Set Point 1 Output High Limit: Select **0** to **100%** but not less than **S IOL** for output codes 1, 2, 3, 4, or 8. Select **0** to **102%** but not less than **S IOL** for output code 5. This item allows setting the maximum output limit. This is useful with processes that are over powered. Adjustment to 102% allows setting current output to force a full on condition for output devices which do not have bias adjustments. Factory set to **100** for all output codes.

If **Out 1** is set for **##tP**, **#PUL**, or **ProP**, then skip to **S ILP** below.

If **Out 1** is set to **OnOF** (in the Secondary Menu), then the next three menu items can make the **SP 1** and **SP Id** settings act like a high or low alarm set point. See the information on alarm settings and the cautions and warnings that apply to them on Pages 31-32.

Note that when Set Point 1 Power Interrupt, **S IP**, is **On**, and Set Point 1 Reset, **S IrE**, is programmed to **Hold**, the SP1 output will automatically reset upon a power failure and subsequent restoration, if the process is below **SP 1**.

S IrE Set Point 1 Reset. Select **OnOF** or **Hold**.
OnOF Output will automatically reset when process passes back through **SP Id**.
Hold Manual Reset. Reset (acknowledge) by simultaneously pressing the   **INDEX & DOWN ARROW** keys for 3 seconds.

S IP Set Point 1 Power Interrupt. Select **On** or **OFF**.
On Alarm Power Interrupt is **On**. Output will automatically reset on power-up if no alarm condition exists.
OFF Alarm Power Interrupt is **OFF**. Output will be in the alarm condition on power-up regardless of condition of process.

S IH Set Point 1 Inhibit: Select **On** or **OFF**.
On Alarm Inhibit is **On**. Alarm action is suspended until the process value first enters a non-alarm condition.
OFF Alarm Inhibit is **OFF**.

S ILP Set Point Lamp: Select **On** or **OffF**.
On Lamp ON when Output is ON.
OffF Lamp OFF when Output is ON.

If your control is not equipped with Set Point 2, then proceed to the alarm section (next page).

- SP2t** Set Point 2 type: Select **ABS** or **dE**.
- ABS** Absolute **SP2**. **SP2** is independent of **SP 1**, and may be set anywhere between the limits of **SPH** and **SPH**.
- dE** Deviation **SP2**. **SP2** is set as a deviation from **SP 1**, and allows **SP2** to retain its relationship with **SP 1** when **SP 1** is changed (**SP2** tracks **SP 1**).
- SP2St** Set Point 2 State: Select **dir** or **rE**.
- dir** Direct Action. As the input increases the output will increase. Most commonly used in cooling processes.
- rE** Reverse Action. As the input increases the output will decrease. Most commonly used in heating processes.



If **Out2** is set for **##LP**, **#PUL**, or **PrOP**, then **S2OL** and **S2OH** appear. If **Out2** is set for **OnOF**, then skip to **S2rE**.

If **Out2** is set to **OnOF** (in the Secondary Menu), then the next three menu items can make the **SP2** and **SP2d** settings act like a high or low alarm set point. See the information on alarm settings and the cautions and warnings that apply to them on the next pages.

Note that when Set Point 2 Power Interrupt, **SP 1** is **On**, and Set Point 2 Reset, **S2rE**, is programmed to **Hold**, the SP2 output will automatically reset upon a power failure and subsequent restoration, if the process is below **SP2**.

S2OL Set Point Output Low Limit: Select **0** to **100%** but not greater than **S2OH**. This item limits the lowest output value. This is useful for adding a bias to the process when needed. Factory set to **0** for output codes 1,2, 3,4, and 8. Factory set to **20** for output code 5 (20% output equals 4 mA output).

S2OH Set Point 1 Output High Limit: Select **0** to **100%** but not less than **S2OL** for output codes 1, 2, 3,4, or 8. Select **0** to **102%** but not less than **S2OL** for output code 5. This item allows setting the maximum output limit. This is useful with processes that are over powered. Adjustment to 102% allows setting current output to force a full on condition for output devices which do not have bias adjustments. Factory set to **100** for all output codes.

- SP-E** Set Point 2 Reset. Select **OnOFF** or **Hold**.
- OnOFF** Output will automatically reset when process passes back through **SP2d**.
- Hold** Manual Reset. Reset (acknowledge) by simultaneously pressing the   **INDEX & DOWN ARROW** keys for 3 seconds.
- SP-I** Set Point 2 Power Interrupt. Select **On** or **OFF**.
- On** Alarm Power Interrupt is **On**. Output will automatically reset on power-up if no alarm condition exists.
- OFF** Alarm Power Interrupt is **OFF**. Output will be in the alarm condition on power-up regardless of condition of process.
- SP-IH** Set Point 2 Inhibit: Select **On** or **OFF**.
- On** Alarm Inhibit is **On**. Alarm action is suspended until the process value first enters a non-alarm condition.
- OFF** Alarm Inhibit is **OFF**.
- SP-LP** Set Point 2 Lamp: Select **On** or **Off**.
- On** Lamp ON when Output is ON.
- Off** Lamp OFF when Output is ON.

ALARM TYPE AND ACTION (if alarm function is present)



Caution: In any critical application where failure could cause expensive product loss or endanger personal safety, a redundant limit controller is required.

When setting an alarm value for an absolute alarm (**Al = Abs**), simply set the value at which the alarm is to occur.

When setting the alarm value for a deviation alarm (**Al = dE**), set the difference in value from the Set Point desired. For example if a low alarm is required to be 5 degrees below the Set Point, then set **Al Lo** to **-5**. If a high alarm is required 20 degrees above the Set Point, then set **Al Hi** to **+20**. If the Set Point is changed, the alarm will continue to hold the same relationship as originally set.

The diagram below shows the action and reset functions for both absolute and deviation alarms.

ABSOLUTE ALARMS

DEVIATION ALARMS

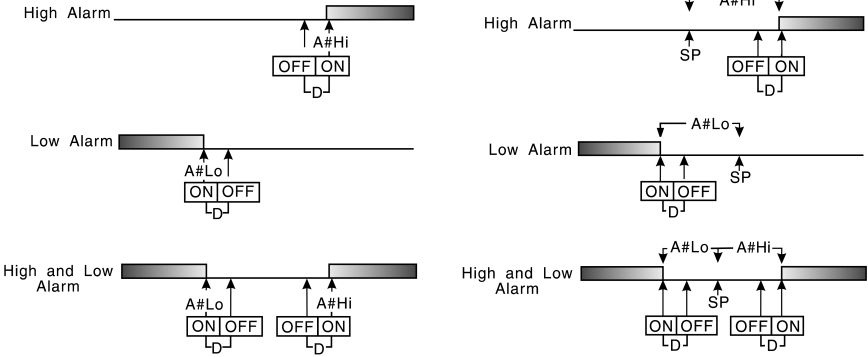

D = 1 degree F, 1 degree C, or 1 count.

Note that when Alarm Power Interrupt, **AIP**, is programmed **On** and Alarm Reset, **ARE**, is programmed for **Hold**, the alarm will automatically reset upon a power failure and subsequent restoration if no alarm condition is present.

If Alarm Inhibit, **AiH**, is selected **On**, an alarm condition is suspended upon power up until the process value passes through the alarm set point once. Alarm inhibit can be restored as if a power up took place by pressing both the **INDEX** and **ENTER** keys for 3 seconds.



WARNING: IF INHIBIT IS ON AND A POWER FAILURE OCCURS DURING A HIGH ALARM, RESTORATION OF POWER WILL NOT CAUSE THE ALARM TO OCCUR IF THE PROCESS VALUE DOES NOT FIRST DROP BELOW THE HIGH ALARM SETTING. DO NOT USE THE ALARM INHIBIT FEATURE IF A HAZARD IS CREATED BY THIS ACTION. BE SURE TO TEST ALL COMBINATIONS OF HIGH AND LOW ALARM INHIBIT ACTIONS BEFORE PLACING CONTROL INTO OPERATION.



The following menu items apply only to the alarm.

- AL1** Alarm 1 function: Select **OFF**, **Lo**, **Hi**, **HiLo**, or **Enable**.
- OFF** Alarm 1 is disabled. No Alarm 1 menu items appear in the Secondary or Secure menus.
- Lo** Low Alarm Only. **ALLo** appears in the Secondary Menu.
- Hi** High Alarm Only. **ALHi** appears in the Secondary Menu.
- HiLo** High and Low Alarms. Both **ALLo** and **ALHi** appear in the Secondary Menu, and share the same Alarm 1 Relay output.

EUnt Alarm 1 is controlled by the Ramp/Soak program function. (CT16A3). See pages 10-13 and 24 (#A 1) for further information.

If **AL 1** is set to **OFF** and the control is not equipped with options, the Secure Menu ends here. If **AL 1** is set to **OFF** and the control is equipped with options, proceed to **SPSA, Addr**, or **rSCL** below.

If **AL 1** is set to **EUnt**, go to **R 1St** below.

- R 1t** Alarm 1 Type: Select **AbS** or **dE**
- AbS** Absolute Alarm that may be set anywhere within the values of **SCAL** and **SCAH** and is independent of **SP 1**.
- dE** Deviation Alarm that may be set as an offset from **SP 1**. As **SP 1** is changed the Alarm Point will track with **SP 1**. A deviation alarm will also track any active ramp or soak set point.
- R 1rE** Alarm 1 Reset: Select **OnOF** or **HoLd**.
- OnOF** Automatic Reset.
- HoLd** Manual Reset. Reset (acknowledge) by simultaneously pressing the   **INDEX & DOWN ARROW** keys for 3 seconds.
- R 1P 1** Alarm 1 Power Interrupt: Select **On** or **OFF**.
- On** Alarm Power Interrupt is **On**.
- OFF** Alarm Power Interrupt is **OFF**.
- R 1IH** Alarm 1 Inhibit: Select **On** or **OFF**.
- On** Alarm Inhibit is **On**. Alarm action is suspended until the process value first enters a non-alarm condition.
- OFF** Alarm Inhibit is **OFF**.
- R 1St** Alarm 1 Output State: Select **CLOS** or **OPEn**.
- CLOS** Closes Contacts at Alarm Set Point.
- OPEn** Opens Contacts at Alarm Set Point.
- R 1LP** Alarm 1 Lamp: Select **On** or **OffF**.
- On** Alarm Lamp is ON when alarm contact is closed.
- OffF** Alarm Lamp is OFF when alarm contact is closed.
- R 1Lb** Alarm 1 Loop Break. Select **On** or **OFF**.
- On** Loop Break Condition will cause an Alarm Condition.
- OFF** Loop Break will not affect the Alarm Condition.
- SPSA** (Option 948, 4-Stage Set Point) Switch Action: Select **rE** or **Int**.
- rE** Set Point Stage selected by external contact closures.
- Int** Set Point Stage selected by internal menu selection. See **SP** menu item in Secondary Menu.

- Addr** (Option 992, 993, Serial Communications) Control Address: Set from **1** to **3FF**. This number (hexadecimal, base 16) must match the address number used by the host computer. Power to instrument must be turned off and on before change takes effect (see Page 18).
- baud** (Option 992, 993, Serial Communications) Communication Baud Rate: Select **300, 1200, 2400, 4800, 9600** (baud), **19.2, 28.8, and 57.6** (kbaud). This number must match the baud rate used by the host computer. Power to instrument must be turned off and on before change takes effect (see Page 18).
- naT** (Option 992, 993, Serial Communications) No Activity Timer: Select **OFF** or **1** to **99** minutes.
1 - 99 Maximum time between host computer accesses. If timer counts to 0, **CHCC LoRE** will be displayed.
OFF No Activity Timer function is disabled.
- rSCL** (Option 924, 926, 928, Analog Remote Set Point) Remote Scale Low: Select **100** to **9999** counts below **rSCH**. The total span between **rSCL** and **rSCH** must be within 11998 counts. Maximum setting range is -1999 to +9999 counts.
- rSCH** (Option 924, 926, 928, Analog Remote Set Point) Remote Scale High: Select **100** to **9999** counts above **rSCL**. The total span between **rSCL** and **rSCH** must be within 11998 counts. Maximum setting range is -1999 to +9999 counts.

ERROR MESSAGES

Any error message may be cleared by using the 'Global Reset' by pressing and holding the   **INDEX & ENTER** keys for five seconds.

DISPLAY	MEANING	SP OUTPUTS	ACTION REQUIRED
ArER (Alternates with PV)	This message appears if the ambient temperature of the control approaches the ends of tolerance.	Set point outputs active Alarm active	Correct the ambient temperature conditions. Ventilate the area of the cabinet or check for clogged filters. If internal temperature sensor (RJC located in terminal 2) is broken, return to factory for service.
ArER	This message appears if the ambient temperature of the control is out of range or RJC sensor is broken.	Set point outputs active Alarms active	Correct the ambient temperature conditions. Ventilate the area of the cabinet or check for clogged filters. If internal temperature sensor is broken, return to factory for service.

ERROR MESSAGES

Any error message may be cleared by using the 'Global Reset' by pressing and holding the   INDEX & ENTER keys for five seconds.

DISPLAY	MEANING	SP OUTPUTS	ACTION REQUIRED
<i>UFL</i> or <i>OFL</i>	Underflow or Overflow: Process value has exceeded input range ends.	Set point outputs active Alarm active	May be normal if Input signals go above or below range ends. If not the case, check sensor, input wiring and correct.
	<i>UFL</i> or <i>OFL</i> will sequence to display one of these messages if the <i>inPt</i> is set for a time value.	Set point outputs inactive Alarm active	When <i>inPt</i> (input fault timer) has been set for a time, the outputs will be turned off after the set time. Setting the time to <i>OFF</i> causes the outputs to remain active, however <i>UFL</i> or <i>OFL</i> will still be displayed. Correct or replace sensor.
<i>bAd</i> <i>inP</i>	For RTD inputs RTD is open or shorted.		Correct or replace sensor.
<i>OPEn</i> <i>inP</i>	For THERMOCOUPLE inputs thermocouple is open.		Correct or replace sensor. Clear with 'Global Reset'.
<i>LOOP</i> <i>bAd</i>	The sensor may be defective, heater fuse open, heater open, or the final power output device is bad.	Set point outputs inactive. Alarm active.	Correct or replace sensor, or any element in the control loop that may have failed. Correct the problem. Clear with 'Global Reset'
<i>SEnC</i> <i>bAd</i>	Sensor Rate of Change exceeded the programmed limits set for <i>SEnC</i> .	Set point outputs inactive. Alarm active	Check for the cause of the error. The value setting may be too slow for the process, or the sensor is intermittent. Correct the problem. Clear with 'Global Reset'.
<i>CHEC CAL</i>	Check calibration appears as an alternating message if the instrument calibration nears tolerance edges.	Set point outputs active Alarm active	Remove the instrument for service and / or recalibration.
	Check calibration appears as a flashing message if the instrument calibration exceeds specification.	Set point outputs inactive Alarm active	Remove the instrument for service and / or recalibration.

ERROR MESSAGES

Any error message may be cleared by using the 'Global Reset' by pressing and holding the   INDEX & ENTER keys for five seconds.

DISPLAY	MEANING	SP OUTPUTS	ACTION REQUIRED
No display lighted	Display is blank. Instrument is not getting power, or the supply voltage is too low.	Set point outputs inactive Alarm inactive	Check that the power supply is on, measure supply voltage, check that the external fuses are good.
FAIL TEST	Fail test appears upon power up if the internal diagnostics detect a failure. This message may occur during operation if a failure is detected. Displays flash.	Set point outputs inactive Alarm inactive	The display alternates between FAIL TEST and one of the following messages: FACT dFLE : Memory may be corrupted. Press the ENTER key and the DOWN ARROW key to return control to the factory default settings. Recheck controller programming. rEt FAcE : Unrecoverable error, return to factory for service.
CHEC SP 1, CHEC SP2, CHEC ISP, ..., CHEC iSP,	This message will appear upon power up if SP 1, SP2, #SP 1, or ##SP is set outside of the SPL or SPH values.	Set point outputs inactive Alarm active	Correct the SP 1 , etc. or adjust the SPL or SPH values by programming new values.
CHEC SPL or CHEC SPH	This message appears at power up if SPL or SPH values are programmed outside the input range ends.	Set point outputs inactive Alarm inactive	Correct the SPL or SPH values by programming new values.
CHEC rSPt	This message appears if the analog remote setpoint signal is out of range.	Set point outputs active Alarm inactive	The control will revert to SP 1 . Correction of the analog signal or turning OFF the rSPt clears the error message.
CHEC LorE	This message appears if the Serial Communications has timed out.	Set point outputs active Alarm inactive	Change the LorE to LOC . Restore the communications line and switch LorE back to rE .

SPECIFICATIONS

Selectable Inputs: Thermocouple, RTD, DC Voltage, or DC Current selectable.

Input Impedance:

Thermocouple = 3 megohms minimum. RTD current = 200 μ A.

Current = 10 ohms. Voltage = 5000 ohms.

Sensor Break Protection: De-energizes control output to protect system after customer set time. (See *inPt* in Secure Menu.)

Set Point Range: Selectable (See Input Ranges Page 39).

Display: Two 4 digit, 7 segment 0.3" high LEDs.

Control Action: Reverse (usually heating), Direct (usually cooling) selectable.

Proportional Band: 1 to 9999 $^{\circ}$ F, $^{\circ}$ C, or counts.

Reset Time (Integral): Off or 0.1 to 99.9 minutes.

Rate Time (Derivative): Off or 0.01 to 99.99 minutes.

Cycle Rate: 1 to 80 seconds.

On - Off Differential: Adjustable 1 $^{\circ}$ F, 1 $^{\circ}$ C, or 1 count to full scale in 1 $^{\circ}$ F, 1 $^{\circ}$ C, or 1 count steps.

Alarm On - Off Differential: 1 $^{\circ}$ F, 1 $^{\circ}$ C, or 1 count.

Fuzzy Percent: 0 to 100%.

Fuzzy Rate: Off or 0.01 to 99.99 counts per second.

Fuzzy Band: Off or 1 to 4000 $^{\circ}$ F, $^{\circ}$ C, or counts.

Accuracy: \pm 0.25% of span, \pm 1 least significant digit.

Resolution: 1 degree or 0.1 degree, selectable.

Line Voltage Stability: \pm 0.05% over the supply voltage range.

Temperature Stability: 4 μ V/ $^{\circ}$ C (2.3 μ V/ $^{\circ}$ F) typical, 8 μ V/ $^{\circ}$ C (4.5 μ V/ $^{\circ}$ F) maximum (100 ppm / $^{\circ}$ C typical, 200 ppm / $^{\circ}$ C maximum).

Common Mode Rejection: 140 db minimum at 60 Hz.

Normal Mode Rejection: 65 db typical, 60 db at 60 Hz.

Isolation:

Relay and SSR outputs: 1500 Vac to all other inputs and outputs.

SP1 and SP2 Current outputs: 500 Vac to all other inputs and outputs, but not isolated from each other,

SP1 and SP2 Switched Voltage outputs: 500 Vac to all other inputs and outputs, but not isolated from each other.

Process Output (934, 936): 500 VAC to all other inputs and outputs.

Supply Voltage: 100 to 240 Vac, nominal, +10 -15%, 50 to 400 Hz. single phase; 132 to 240 Vdc, nominal, +10 -20%.

Supply Voltage (Option 9502): 12 to 24 Vdc, Vac 40-400 Hz, $\pm 20\%$.

Power Consumption: 5VA maximum.

Operating Temperature: -10 to +55 °C (+14 to 131 °F).

Storage Temperature: -40 to +80 °C (-40 to 176 °F).

Humidity Conditions: 0 to 90% up to 40 °C non-condensing, 10 to 50% at 55 °C non-condensing.

Memory Backup: Nonvolatile memory. No batteries required.

Control Output Ratings:

SSR: 2.0 A combined outputs A & B @ 240 Vac at 25 °C (77°F). Derates to 1.0 A @ 55° C (130°F).

Relay: SPST, 3 A @ 240 Vac resistive; 1.5A @ 240 Vac inductive; Pilot duty rating 240 VA, 2 A @ 120 Vac or 1 A 240 Vac.

Alarm Relay: SPST, 3 A @ 240 Vac resistive; 1/10 HP @ 120 Vac.

Current (isolated): 0 to 20 mA across 600 ohms maximum.

Switched Voltage (isolated): 15 Vdc @ 20 mA.

DC SSR: 1.75 A @ 32 Vdc maximum.

Panel Cutout: 45 mm x 45 mm (1.775" x 1.775").

Depth Behind Mounting Surface: 121.6 mm (4.79") maximum.

Weight: 220 g (8 oz).

Agency Approvals: UL, C-UL E169128; CE.

Front Panel Rating: IP66, (UL Type 4X).

Input Ranges (Field Selectable)

Thermocouple Types

Input Type	Type J or L*	Type K*	Type T*	Type E*
Range 1°F 1°C	-100 to +1600 -73 to +871	-200 to +2500 -129 to +1371	-350 to +750 -212 to +398	-100 to +1800 -73 to +982
Input Type	Type R	Type S	Type B	Type C
Range 1°F 1°C	0 to 3200 -17 to +1760	0 to 3200 -17 to +1760	+75 to 3308 +24 to 1820	0 to 4208 -17 to 2320
Input Type	Type N*	* These Input Types can be set for 0.1° display. If temperature goes above 999.9° or less than -199.9° the display will return to whole degree resolution.		
Range 1°F 1°C	-100 to +2372 -73 to +1300			

RTD Types

Input Type	100 Ohm Platinum 0.00385 IEC/ DIN Curve*	100 Ohm Platinum 0.00392 NIST Curve*	120 Ohm Nickel 0.00628 US Ind. Curve*	1000 Ohm Platinum 0.00385 IEC/ DIN Curve*
Range 1°F 1°C	-328 to +1607 -200 to +875	-328 to +1607 -200 to +875	-112 to +608 -80 to +320	-328 to +1607 -200 to +875

Process Input Types

The 0 to 20 mAdc, 4 to 20 mAdc, 0 to 10 Vdc, 2 to 10 Vdc, and -10 to +10 mVdc inputs are fully scalable from a minimum of 100 counts span placed anywhere within the within the range of -1999 to +9999. Decimal point position is adjustable for the zero place (9999), tenths (999.9), hundredths (99.99), thousandths (9.999), or ten thousandths (.9999).

DIMENSIONS

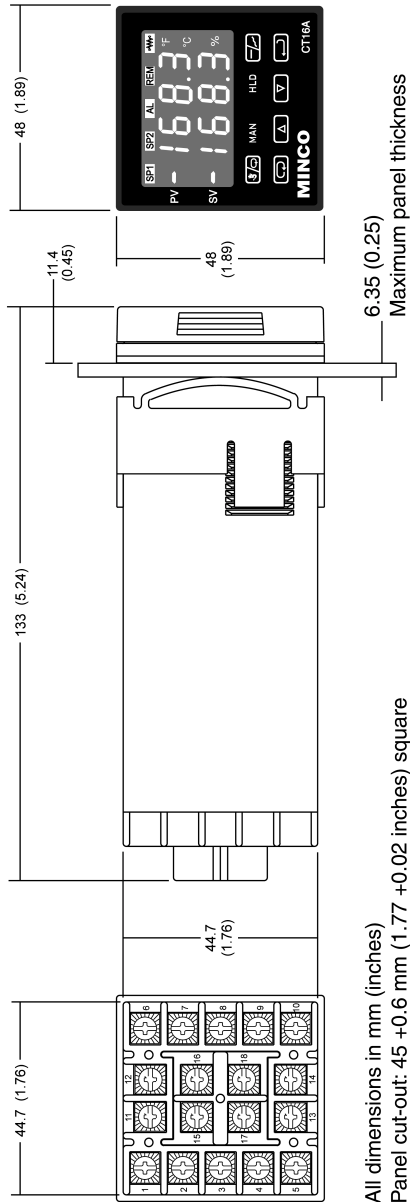

All dimensions in mm (inches)
 Panel cut-out: 45 +0.6 mm (1.77 +0.02 inches) square



www.mod-tronic.com | sales@mod-tronic.com | 1-800-794-5883