

To prevent accidents arising from the misuse of this controller, please ensure the operator using it receives this manual.

Warning

Turn the power supply to the instrument off before wiring or checking it.
Working or touching the terminal with the power switched on may result in severe injury or death due to Electric Shock.

1. System configuration

RS-485 multi-drop connection communication (Option: C5)

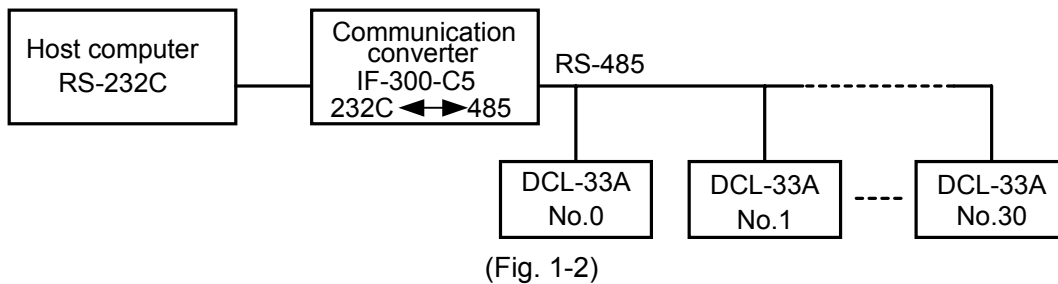
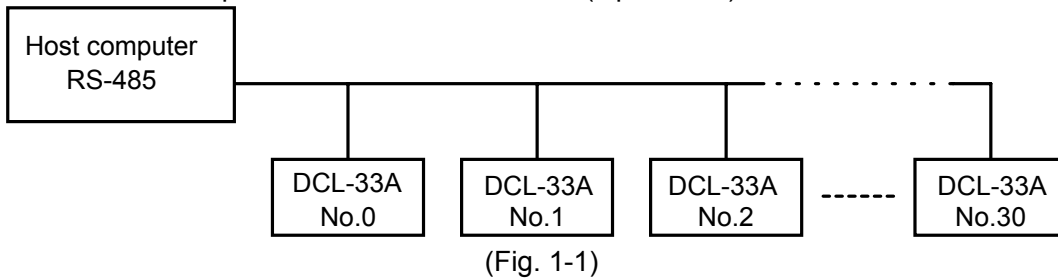

Note: When communication converter IF-300-C5 is used, Modbus protocol is not available.

2. Wiring connection

When using communication converter IF-300-C5 (RS-232C)

- Connector: D sub 25-pin
- Connection: RS-232C ↔ RS-485 (Communication speed: 2400, 4800, 9600, 19200bps)

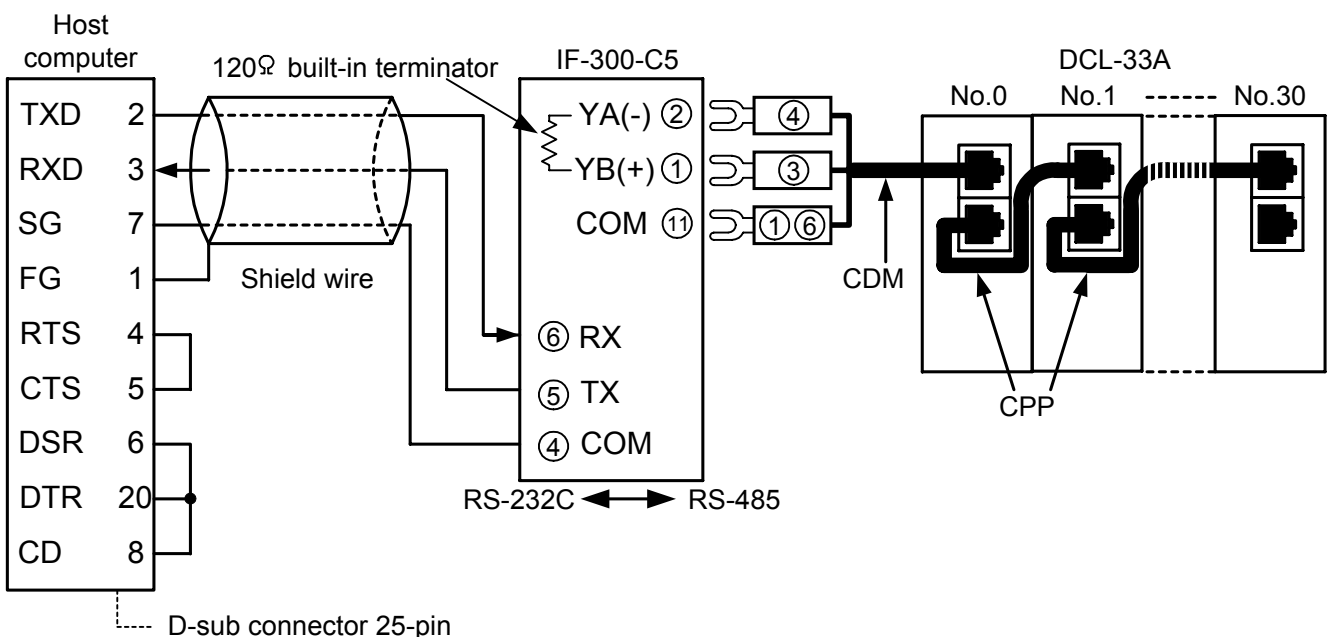

- Connector: D sub 9-pin
Connection: RS-232C ↔ RS-485 (Communication speed: 2400, 4800, 9600, 19200bps)

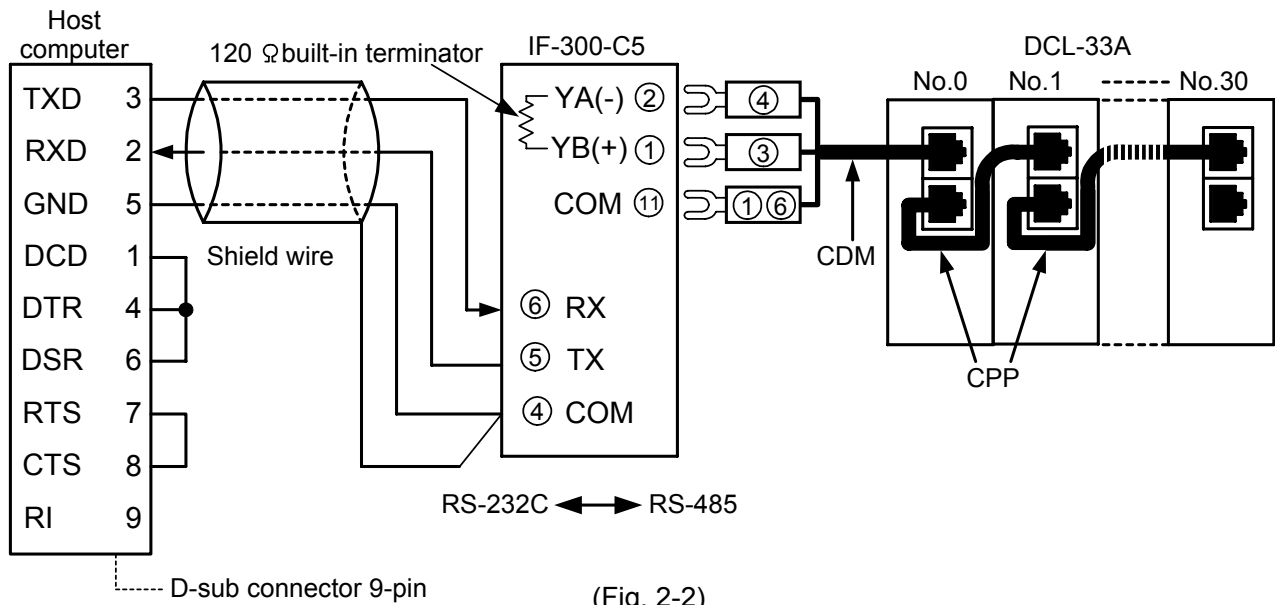

Shield wire

Connect only one side of the shield wire to the FG or GND terminal so that current cannot flow to the shield wire.

(If both sides of the shield wire are connected to the FG or GND terminal, the circuit will be closed between the shield wire and the ground. As a result, current will run through the shield wire and this may cause noise.)

Never fail to ground FG and GND terminals.

Terminator (Terminal resistor)

Do not connect terminator with the communication line because each DCL-33A has built-in pull-up and pull-down resistors instead of a terminator.

IF-300-C5 (sold separately) is available as a communication converter.

3. Setup of the DCL-33A

- It is necessary to set the instrument number individually to the DCL-33A when communicating by connecting plural units in serial communication (option C5).
Select a communication speed of the DCL-33A in accordance with that of the host computer.
- For the instrument number setting and communication speed selection, refer to the instruction manual for DCL-33A.

4. Communication procedure

Communication starts with command transmission from the host computer (hereafter Master) and ends with the response of the DCL-33A (hereafter Slave).

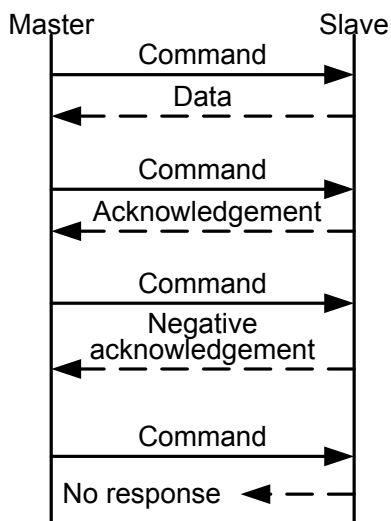

(Fig.4-1)

• Response with data

When the master sends the reading command, the slave responds with the corresponding setting value or current status.

• Acknowledgement

When the master sends the setting command, the slave responds by sending the acknowledgement after the processing is terminated.

• Negative acknowledgement

When the master sends non-existent command or value out of the setting range, the slave returns the negative acknowledgement.

• No response

The slave will not respond to the master when global address is set, or when there is a communication error (framing error or checksum error), or when LRC or CRC discrepancy is detected.

Communication timing of the RS-485 (option C5)

Slave side

When the slave starts transmission to RS-485 communication line, the slave is arranged so as to provide an idle status (mark status) **transmission period of 1 or more characters** before sending the response to ensure the synchronization on the receiving side.

The slave is arranged so as to disconnect the transmitter from the communication line **within a 1 character transmission period** after sending the response.

Master side (Notice on programming)

Set the program so that the master can disconnect the transmitter from the communication line **within a 1 character transmission period** after sending the command in preparation for reception of the response from the slave.

To avoid the collision of transmissions between the master and the slave, send the next command after carefully checking that the master received the response.

Note:

When the master communicates with the slave through the line converter (IF-300-C5), it is not required to manage the transmission timing described above, because the converter takes the timing interpreting the protocol automatically.

5. Shinko protocol

5.1 Transmission mode

Shinko protocol is composed of ASCII codes.

Hexadecimal (0 to 9, A to F), which is divided into high order (4-bit) and low order (4-bit) out of 8-bit binary data in command is transmitted as ASCII characters.

Data format Start bit : 1 bit
 Data bit : 7 bits
 Parity : Even
 Stop bit : 1 bit
 Error detection: Checksum

5.2 Command configuration

All commands are composed of ASCII. The data (setting value, decimal number) is represented with hexadecimal number, and ASCII code is used.

The negative numbers are represented with 2's complement.

(1) Setting command

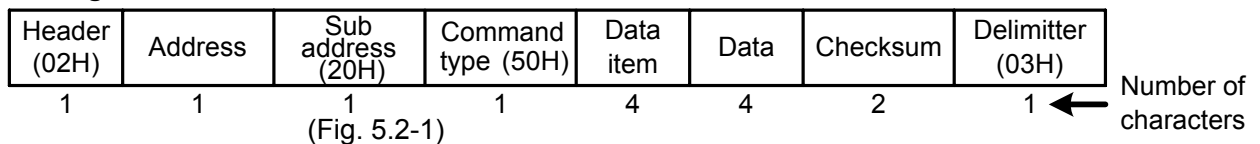

(2) Reading command

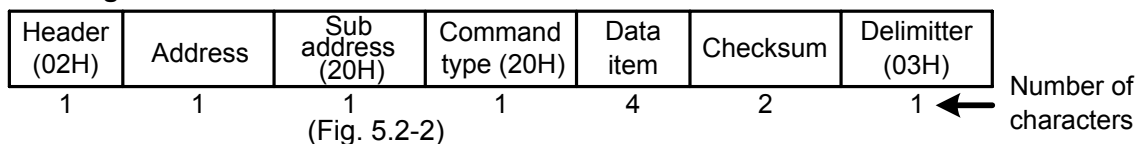

(3) Response with data

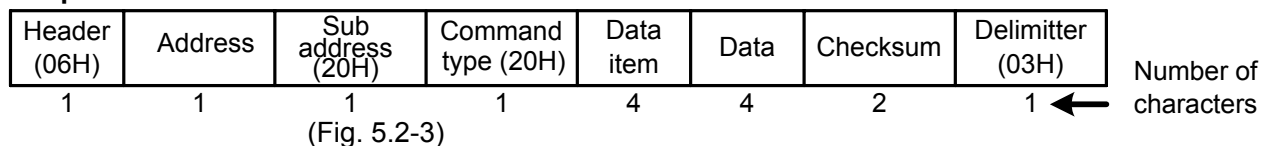

(4) Acknowledgement

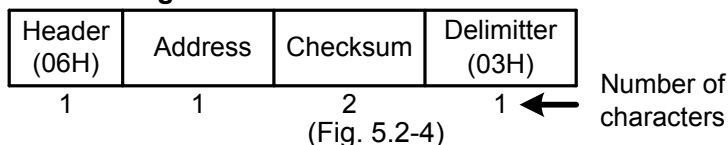

(5) Negative acknowledgement

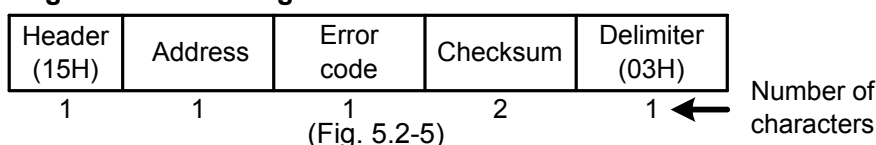

Header : Control code to represent the beginning of the command or the response. ASCII codes are used.

Setting command, Reading command : 02H fixed

Response with data, Acknowledgement: 06H fixed

Negative acknowledgement : 15H fixed

- The memory can store up to 1,000,000 (one million) entries.
If the number of setting times exceeds the limit, it cannot memorize the data. So frequent transmission via communication is not recommended.
- When connecting plural slaves, the address (instrument number) must not be duplicated.
- When sending a command by Global address [95 (7FH)], the same command is sent to all the slaves connected. However, the response is not returned.
- The instrument number and communication speed of the slave cannot be set by communication.

Setting command

- The settable range is the same as the one by keypad operation.
For communication command, refer to the communication command table of this manual.
- All commands are composed of ASCII.
- The data (setting value, decimal) is converted to hexadecimal figures, and ASCII is used.
The negative number is represented with 2's complement. When the data (setting value) has a decimal point, the whole number without a decimal point is used.

Reading command

- All commands are composed of ASCII.
- The data (setting value, decimal) is converted to hexadecimal figures, and ASCII is used.
The negative number is represented by 2's complement. When the data (setting value) has a decimal point, the response is returned as a whole number without a decimal point.

6. Modbus protocol

6.1 Transmission mode

There are 2 transmission modes (ASCII and RTU) in Modbus protocol.

6.2 ASCII mode

Hexadecimal (0 to 9, A to F), which is divided into high order (4-bit) and low order (4-bit) out of 8-bit binary data in command is transmitted as ASCII characters.

Data format Start bit : 1 bit
 Data bit : 7 bits
 Parity : Even/No/Odd (Selectable)
 Stop bit : 1 bit/2 bits (Selectable)
 Error detection: LRC (Longitudinal Redundancy Check)
 Data interval : 1 second or less

(1) Message configuration

ASCII mode message is configured to start by [: (colon)(3AH)] and end by [CR (carriage return) (0DH) + LF (Line feed)(0AH)]. (See Fig. 6.2-1)

Header (:)	Slave address	Function code	Data	Error check LRC	Delimiter (CR)	Delimiter (LF)
---------------	------------------	------------------	------	--------------------	-------------------	-------------------

(Fig. 6.2-1)

(2) Slave address

Slave address is an individual instrument number on the slave side and is set within the range 00H to 5FH (0 to 95).

The master identifies slaves by the slave address of the requested message.

The slave informs the master which slave is responding to the master by placing its own address in the response message.

[Slave address 00H (broadcast address) can identify all the slaves. However slaves do not respond.]

(3) Function code

The function code is the command code for the slave to undertake the following action types (Table 6.2-1). (Table 6.2-1)

Function code	Contents
03 (03H)	Reading the setting value and information from slaves
06 (06H)	Setting to slaves

Function code is used to discern whether the response is normal (acknowledgement) or if any error (negative acknowledgement) is occurred when the slave returns the response message to the master. When acknowledgement is returned, the slave simply returns the original function code.

When negative acknowledgement is returned, the MSB of the original function code is set as 1 for the response.

(For example, when the master sends request message setting 10H to function code by mistake, slave returns 90H by setting the MSB to 1, because the former is an illegal function.)

For negative acknowledgement, abnormal code (Table 6.2-2) below is set to the data of response message and returned to the master in order to inform it that what kind of error has occurred.

(Table 6.2-2)

Abnormal code	Contents
1 (01H)	Illegal function (Non-existent function)
2 (02H)	Illegal data address (Non-existent data address)
3 (03H)	Illegal data value (Value out of the setting range)
17 (11H)	Illegal setting (Unsettable status)
18 (12H)	Illegal setting (During setting mode by key operation, etc)

(4) Data

Data depends on the function code.

A request message from the master is composed of data item, number of data and setting data.

A response message from the slave is composed of number of bytes, data and abnormal code in negative acknowledgement. Effective range of data is -32768 to 32767 (8000H to 7FFFH).

(5) Error check of ASCII mode

After calculating LRC (Longitudinal Redundancy Check) from the slave address to the end of data, the calculated 8-bit data is converted to two ASCII characters and are appended to the end of message.

How LRC is calculated

- ① Create a message in RTU mode.
- ② Add all the values from the slave address to the end of data. This is assumed as X.
- ③ Make a complement for X (bit reverse). This is assumed as X.
- ④ Add a value of 1 to X. This is assumed as X.
- ⑤ Set X as an LRC to the end of the message.
- ⑥ Convert the whole message to ASCII characters.

(6) Message example of ASCII mode**① Reading (Instrument number 1, SV)**

- A request message from the master

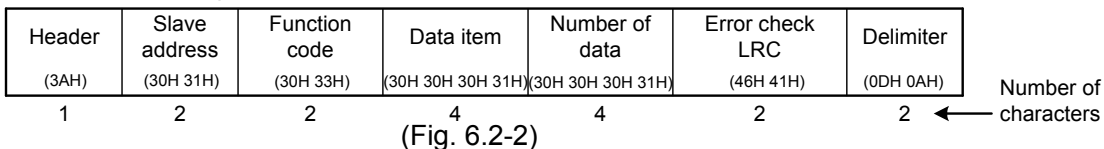

The number of data means the data item to be read, and it is fixed as (30H 30H 30H 31H).

- A response message from the slave in normal status (When SV=100°C)

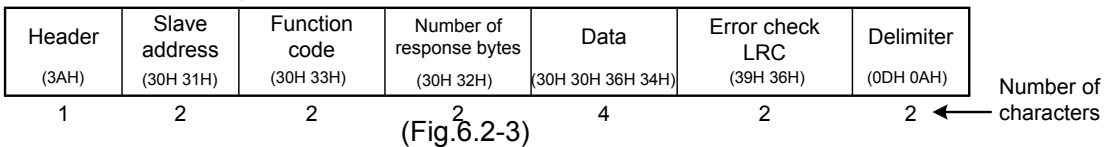

The number of response bytes means the number of bytes of the data which has been read, and it is fixed as (30H 32H).

- A response message from the slave in abnormal status (When non-existent data item is sent)

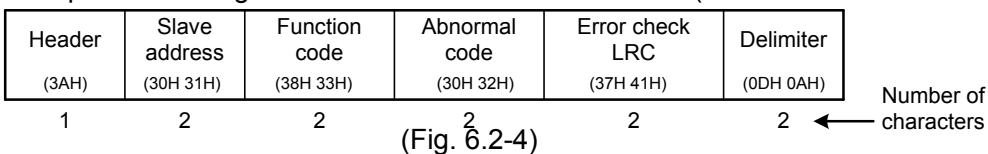

The function code MSB is set to 1 for the response message in abnormal status (83H).

The abnormal code (02H: Non-existent data address) is returned as contents of error.

② Setting (Instrument number 1, SV=100°C)

- A request message from the master

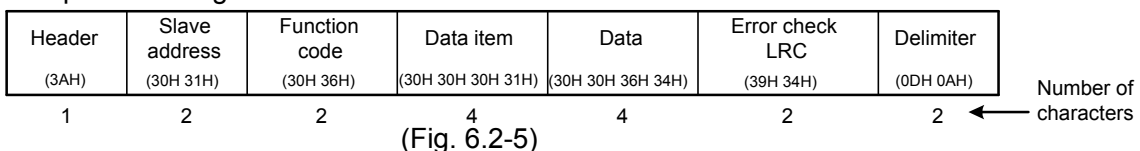

- A response message from the slave in normal status

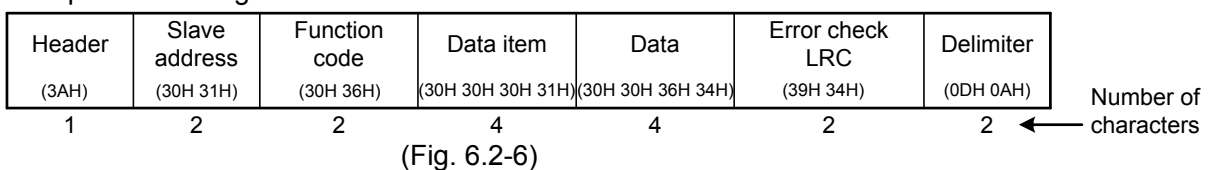

- A response message from the slave in abnormal status (When a value out of the setting range is set.)

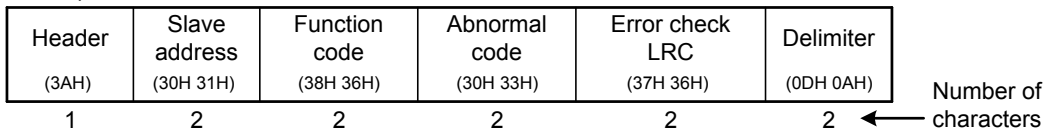

(Fig. 6.2-7)

The function code MSB is set to 1 for the response message in abnormal status (86H).
The abnormal code (03H: Value out of the setting range) is returned as contents of error.

6.3 RTU mode

8-bit binary data in command is transmitted as it is.

Data format Start bit : 1 bit
 Data bit : 8 bits
 Parity : Even/No/Odd (Selectable)
 Stop bit : 1 bit/2 bits (Selectable)
 Error detection : CRC-16 (Cyclic Redundancy Check)
 Data interval : 3.5 characters transmission time or less

(1) Message configuration

RTU mode is configured to start after idle time is processed for more than 3.5 character transmission and end after idle time is processed for more than 3.5 character transmission. (See Fig. 6.3-1)

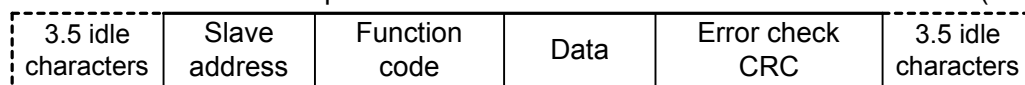

(Fig. 6.3-1)

(2) Slave address

Slave address is an individual instrument number on the slave side and is set within the range 00H to 5FH (0 to 95).

The master identifies slaves by the slave address of the requested message.

The slave informs the master which slave is responding to the master by placing its own address in the response message.

[Slave address 00H (broadcast address) can identify all the slaves. However slaves do not respond.]

(3) Function code

The function code is the command code for the slave to undertake the following action types (Table 6.3-1).

(Table 6.3-1)

Function code	Contents
03 (03H)	Reading the setting value and information from slaves
06 (06H)	Setting to slaves

Function code is used to discern whether the response is normal (acknowledgement) or if any error (negative acknowledgement) is occurred when the slave returns the response message to the master. When acknowledgement is returned, the slave simply returns the original function code.

When negative acknowledgement is returned, the MSB of the original function code is set as 1 for the response.

(For example, when the master sends request message setting 10H to function code by mistake, slave returns 90H by setting the MSB to 1, because the former is an illegal function.)

For negative acknowledgement, abnormal code (Table 6.3-2) below is set to the data of response message and returned to the master in order to inform it that what kind of error has occurred.

(Table 6.3-2)

Abnormal code	Contents
1 (01H)	Illegal function (Non-existent function)
2 (02H)	Illegal data address (Non-existent data address)
3 (03H)	Illegal data value (Value out of the setting range)
17 (11H)	Illegal setting (Unsettable status)
18 (12H)	Illegal setting (During setting mode by keypad operation, etc)

(4) Data

Data depends on the function code.

A request message from the master side is composed of data item, number of data and setting data.

A response message from the slave side is composed of number of bytes, data and abnormal code in negative acknowledgement. Effective range of data is -32768 to 32767 (8000H to 7FFFH).

(5) Error check of RTU mode

After calculating CRC-16 (Cyclic Redundancy Check) from the slave address to the end of data, the calculated 16-bit data is appended to the end of message in sequence from low order to high order.

How CRC is calculated

In the CRC system, the information is divided by the polynomial. The remainder is added to the end of the information and transmitted. The generation of polynomial is as follows.

(Generation of polynomial: $X^{16} + X^{15} + X^2 + 1$)

- ① Initialize the CRC-16 data (assumed as X) (FFFFH).
- ② Calculate exclusive OR (XOR) with the 1st data and X. This is assumed as X.
- ③ Shift X one bit to the right. This is assumed as X.
- ④ When a carry is generated as a result of the shift, XOR is calculated by X of ③ and the fixed value (A001H). This is assumed as X. If a carry is not generated, go to step ⑤.
- ⑤ Repeat steps ③ and ④ until shifting 8 times.
- ⑥ XOR is calculated with the next data and X. This is assumed as X.
- ⑦ Repeat steps ③ to ⑤.
- ⑧ Repeat steps ③ to ⑤ up to the last data.
- ⑨ Set X as CRC-16 to the end of message in sequence from low order to high order.

(6) Message example of RTU mode

① Reading (Instrument number 1, SV)

- Request message from the master

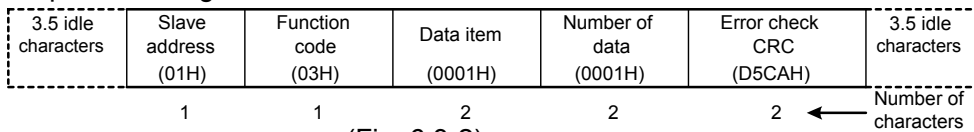

(Fig. 6.3-2)

The number of data means the data item to be read, and it is fixed as 0001H.

- Response message from the slave in normal status (When SV=100°C)

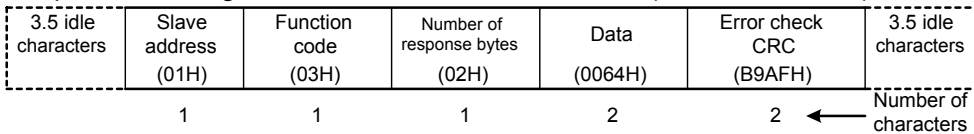

(Fig. 6.3-3)

The number of response byte means number of bytes of the data which has been read, and it is fixed as 02H.

- Response message from the slave in abnormal status (When data item is mistaken)

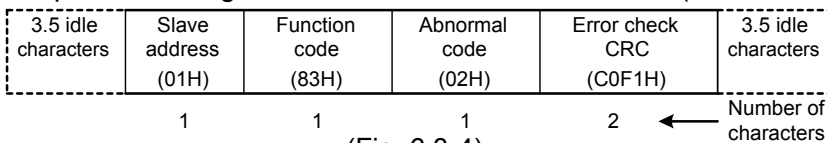

(Fig. 6.3-4)

The function code MSB is set to 1 for the response message in abnormal status (83H). The abnormal code (02H: Non-existent data address) is returned as contents of error.

② Setting (Instrument number 1, SV=100°C)

- Request message from the master

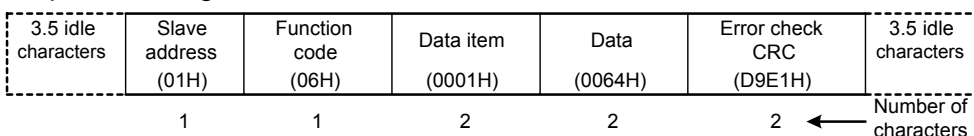

(Fig. 6.3-5)

- Response message from the slave in normal status

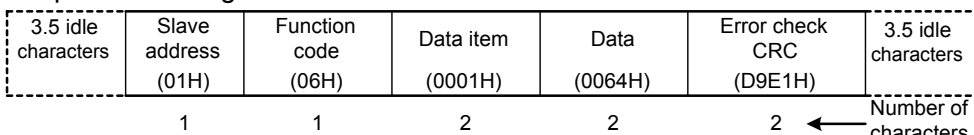

(Fig. 6.3-6)

- Response message from the slave in abnormal status (When a value out of the setting range is set)

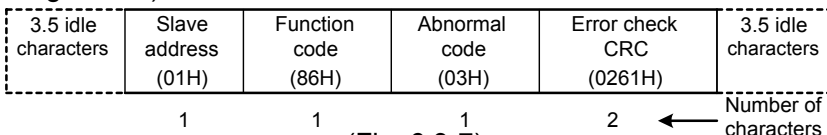

(Fig. 6.3-7)

The function code MSB is set to 1 for the response message in abnormal status (86H). The abnormal code (03H: Value out of the setting range) is returned as contents of error.

7. Communication command table

When the data (setting value) has a decimal point, remove the decimal point and represent it as a whole number, then express it in hexadecimal figures.

Shinko command type	Modbus function code	Data item	Data
20H/50H	03H/06H	0001H: SV	Setting value
20H/50H	03H/06H	0002H: Not used	
20H/50H	03H/06H	0003H: AT setting	0000H: Cancel 0001H: Perform
20H/50H	03H/06H	0004H: OUT proportional band setting	Setting value
20H/50H	03H/06H	0005H: Not used	
20H/50H	03H/06H	0006H: Integral time setting	Setting value
20H/50H	03H/06H	0007H: Derivative time setting	Setting value
20H/50H	03H/06H	0008H: OUT proportional cycle setting	Setting value
20H/50H	03H/06H	0009H: Not used	
20H/50H	03H/06H	000AH: Manual reset setting	Setting value
20H/50H	03H/06H	000BH: Alarm setting	Setting value
20H/50H	03H/06H	000CH: Not used	
20H/50H	03H/06H	000DH: Not used	
20H/50H	03H/06H	000EH: Not used	
20H/50H	03H/06H	000FH: HB (Heater burnout alarm) setting	Setting value
20H/50H	03H/06H	0010H: LA (Loop break alarm) time setting	Setting value
20H/50H	03H/06H	0011H: LA (Loop break alarm) span setting	Setting value
20H/50H	03H/06H	0012H: Setting value lock selection (*1)	0000H: Unlock 0002H: Lock 2 0001H: Lock 1 0003H: Lock 3
20H/50H	03H/06H	0013H: Not used	
20H/50H	03H/06H	0014H: Not used	
20H/50H	03H/06H	0015H: Sensor correction value setting	Setting value
20H/50H	03H/06H	0016H: Not used	
20H/50H	03H/06H	0017H: Not used	
20H/50H	03H/06H	0018H: Scaling high limit setting	Setting value
20H/50H	03H/06H	0019H: Scaling low limit setting	Setting value
20H/50H	03H/06H	001AH: Decimal point place selection	0000H: XXXX (No decimal point) 0001H: XXX.X (1 digit after decimal point) 0002H: XX.XX (2 digits after decimal point) 0003H: X.XXX (3 digits after decimal point)
20H/50H	03H/06H	001BH: PV filter time constant setting	Setting value
20H/50H	03H/06H	001CH: OUT high limit setting	Setting value
20H/50H	03H/06H	001DH: OUT low limit setting	Setting value
20H/50H	03H/06H	001EH: OUT ON/OFF action Hysteresis setting	Setting value
20H/50H	03H/06H	001FH: Not used	
20H/50H	03H/06H	0022H: Not used	
20H/50H	03H/06H	0023H: Alarm action selection (*2)	0000H: No alarm action 0001H: High limit alarm 0002H: Low limit alarm 0003H: High/Low limits alarm 0004H: High/Low limit range alarm 0005H: Process high alarm 0006H: Process low alarm 0007H: High limit alarm with standby 0008H: Low limit alarm with standby 0009H: High/Low limits alarm with standby
20H/50H	03H/06H	0024H: Not used	

20H/50H	03H/06H	0025H: Alarm hysteresis setting	Setting value
20H/50H	03H/06H	0026H: Not used	
20H/50H	03H/06H	0027H: Not used	
20H/50H	03H/06H	0028H: Not used	
20H/50H	03H/06H	0029H: Alarm action delayed timer setting	Setting value
20H/50H	03H/06H	002AH: Not used	
20H/50H	03H/06H	003FH: Not used	
20H/50H	03H/06H	0040H: Alarm action Energized/Deenergized selection	0000H: Energized 0001H: Deenergized
20H/50H	03H/06H	0041H: Not used	
20H/50H	03H/06H	0042H: Alarm HOLD function selection	0000H: HOLD function not applied 0001H: HOLD function applied
20H/50H	03H/06H	0043H: Not used	
20H/50H	03H/06H	0044H: Input type selection	0000H: K [-200 to 1370°C] 0001H: K [-199.9 to 400.0°C] 0002H: J [-200 to 1000°C] 0003H: R [0 to 1760°C] 0004H: S [0 to 1760°C] 0005H: B [0 to 1820°C] 0006H: E [-200 to 800°C] 0007H: T [-199.9 to 400.0°C] 0008H: N [-200 to 1300°C] 0009H: PL-II [0 to 1390°C] 000AH: C (W/Re5-26) [0 to 2315°C] 000BH: Pt100 [-199.9 to 850.0°C] 000CH: JPt100 [-199.9 to 500.0°C] 000DH: Pt100 [-200 to 850°C] 000EH: JPt100 [-200 to 500°C] 000FH: K [-320 to 2500°F] 0010H: K [-199.9 to 750.0°F] 0011H: J [-320 to 1800°F] 0012H: R [0 to 3200°F] 0013H: S [0 to 3200°F] 0014H: B [0 to 3300°F] 0015H: E [-320 to 1500°F] 0016H: T [-199.9 to 750.0°F] 0017H: N [-320 to 2300°F] 0018H: PL-II [0 to 2500°F] 0019H: C (W/Re5-26) [0 to 4200°F] 001AH: Pt100 [-199.9 to 999.9°F] 001BH: JPt100 [-199.9 to 900.0°F] 001CH: Pt100 [-300 to 1500°F] 001DH: JPt100 [-300 to 900°F] 001EH: 4 to 20mA DC [-1999 to 9999] 001FH: 0 to 20mA DC [-1999 to 9999] 0020H: 0 to 1V DC [-1999 to 9999] 0021H: 0 to 5V DC [-1999 to 9999] 0022H: 1 to 5V DC [-1999 to 9999] 0023H: 0 to 10V DC [-1999 to 9999]
20H/50H	03H/06H	0045H: Direct/Reverse action selection	0000H: Heating (Reverse action) 0001H: Cooling (Direct action)
20H/50H	03H/06H	0046H: Not used	
20H/50H	03H/06H	0047H: AT bias setting	Setting value
20H/50H	03H/06H	0048H: ARW (anti-reset windup) setting	Setting value
20H/50H	03H/06H	006FH: Key Lock selection	0000H: Key enabled 0001H: Key Lock
50H	06H	0070H: Key operation change flag clearing	0000H: No action 0001H: All clearing

20H	03H	0080H: PV (input value) reading	Present PV
20H	03H	0081H: MV (manipulated variable) reading	Present MV
20H	03H	0082H: Not used	
20H	03H	0083H: Not used	
20H	03H	0084H: Not used	
20H	03H	0085H: OUT status reading	$\frac{0000}{2^{15}}$ $\frac{0000}{}$ $\frac{0000}{}$ $\frac{0000}{2^0}$ to 2^0 digit: OUT 0: OFF 1: ON 2^1 digit: Not used (Always 0) 2^2 digit: Alarm output 0: OFF 1: ON 2^3 digit: Not used (Always 0) 2^4 digit: Not used (Always 0) 2^5 digit: Not used (Always 0) 2^6 digit: HB (Heater burnout alarm) output 0: OFF 1: ON (When sensor burnout, 0: OFF) 2^7 digit: LA (Loop break alarm) output 0: OFF 1: ON 2^8 digit: Overscale 0: OFF 1: ON 2^9 digit: Underscale 0: OFF 1: ON 2^{10} digit: Not used (Always 0) 2^{11} digit: AT 0: OFF 1: ON 2^{12} digit: Not used (Always 0) 2^{13} digit: Converter function 0: Controller 1: Converter 2^{14} digit: Not used (Always 0) 2^{15} digit: Key operation change 0: No 1: Yes
20H	03H	0086H: Not used	
20H	03H	0087H: Not used	
20H	03H	00A0H: Not used	
20H	03H	00A1H: Instrument information reading	$\frac{0000}{2^{15}}$ $\frac{0000}{}$ $\frac{0000}{}$ $\frac{0000}{2^0}$ to 2^0 digit: Not used (Always 0) 2^1 digit: Not used (Always 0) 2^2 digit: Alarm function 0: Not applied 1: Applied 2^3 digit: Not used (Always 0) 2^4 digit: Not used (Always 0) 2^5 digit: Not used (Always 0) 2^6 digit: HB (Heater burnout alarm) 0: Not applied 1: Applied 2^7 digit: LA (Loop break alarm) 0: Not applied 1: Applied 2^8 to 2^{15} digit: Not used (Always 0)

(*1) When Lock 3 is designated, the set data is not saved in the memory.

This is why the setting value reverts to the one before Lock 3 when power is turned OFF.

(*2) When alarm action type is changed, the alarm setting value reverts to the default value and alarm output status is also initialized.

Notice

When data setting is changed by front keypad operation, the data that is related to the changed item is also changed automatically as shown in Example 1 below.

However, when the data setting is changed by communication function, the related data does not change as shown in Example 2 below. (Only the changed data is altered.)

(Example 1) SV high limit: 1370°C

SV : 1000°C

When SV high limit is changed to 800°C by the front keypad operation, both SV high limit and SV are changed to 800°C.

(Example 2) SV high limit: 1370°C

SV : 1000°C

When SV high limit is changed to 800°C by communication function, SV high limit is changed to 800°C, however, SV is maintained at the same temperature 1000°C.

8. Specifications

Cable length	: Maximum communication distance 1.2km Cable resistance: Within 5Ω (Terminator is not necessary or 12Ω or greater on one side.)
Communication line	: Based on EIA RS-485
Communication method	: Half-duplex
Communication speed	: 9600bps (2400, 4800, 9600, 19200bps) Selectable by keypad operation
Synchronous system	: Start-stop synchronous
Code form	: ASCII, binary
Error correction	: Command request repeat system
Error detection	: Parity check, Checksum (LRC), CRC
Data format	Start bit : 1 Data bit : 7, 8 Parity : Even, Odd, No parity Stop bit : 1

9. Troubleshooting

If any malfunctions occur, refer to the following items after checking the power supply to the master and the slave.

• Problem: If it is unable to communicate

Check the following
The connection or wiring of communication is not secure.
Burnout or imperfect contact on the communication cable and the connector.
Communication speed of the slave does not coincide with that of the master.
The data bit, parity and stop bit of the master do not accord with those of the slave.
The instrument number of the slave does not coincide with that of the command.
The instrument numbers are duplicated in multiple slaves.
When communicating without using communication converter (IF-300-C5), make sure that the program is appropriate for the transmission timing.

• Problem: Though it is able to communicate, the response is 'NAK'.

Check the following
Check whether a non-existent command code has been sent or not.
The setting command data exceeds the setting range of the slave.
The controller cannot be set when functions such as AT is performing.
The operation mode is under the front keypad operation setting mode.

If you have any inquiries, please consult our agency or the shop where you purchased the unit.

Shinko
North America Ltd.

Web Site: www.shinkona.com

Email: sales@shinkona.com

25 Whitefriars Drive
Toronto, Ontario, Canada M3A 2L2
TEL: 416 444-0817
FAX: 416 444-2361
TOLL FREE: 1 888-4SHINKO